

sign holders and ceiling displays

solutions guide



siffron[®]

www.siffron.com | 800.422.2547



new

Allura™ LED Blacklit Data Strip®



Flip Sign Holder with Metal Brackets



Bracket Sign System



RAZZ® System

Sign Holders

Maximize impact with minimal use of space

Judging by the placement of enticing fresh displays at the entrance of nearly every grocery store, retailers are clearly aware that the fresh area is one of the most important sections of a store's layout. But, what makes this area so appealing to customers?

While location at the store entrance seems to be the most important factor, presentation follows a close second. Here are six factors to keep in mind when setting or resetting your fresh area:

- ◆ Keep displays looking full
- ◆ Maintain a flexible layout
- ◆ Merchandise vertically
- ◆ Refrigerate appropriately
- ◆ Use ample lighting
- ◆ Don't forget signage

This guide includes a wide variety of products to help you maximize impact with minimal use of space.



Sign Holders

Modular	4
Sign Frames	7
Headers	10
Channel Systems	14
RAZZ® System	18
Insta-Flag™ Sign System	20
Aisle	22
Bracket Sign System	32
Swivo•Clips™	38
Swivel	45
Shelf Channel	46
Wobblers	55
Perforated Shelves	57
Square Edge	58
Magnetic	62
Glass Shelves	63
Suction Cups	64
Adhesive	65
Card Holders	75
Allura™ LED Backlit Data Strip®	80
Data Strip® Sign Holders	81
Hooks	84
Specialty	85
Wire	88
Vinyl Pockets	93
Wall Mount	97
Freestanding	98
Banner Stands	104

Ceiling Displays

Create a Banner System	112
Ready-Made Banner Kits	113
Banner Hangers	114
Spiral Sign Board System	119
Mobile Kits	120
Specialty Banner Hangers	122
Ceiling Clips	123
Accessories	128

siffron®

Create your own sign solution!

Modular Sign Holders

With Modular Sign Holder Systems, you can mix and match components to meet your needs. All components are interchangeable to offer hundreds of sign solutions.

All frames may be used either horizontally or vertically, offering greater versatility and multiple uses from a single sign frame. Modular Sign holders also offer savings through reduced shipping and storage costs.

- Complete line of interchangeable components.
- High impact polystyrene with miter-edge finish for easy fit of standard-sized signs.
- Light and durable for use with POP and store shelving applications.
- Stock colors are white, black and red.

4" High Shovel Base Sign Holder

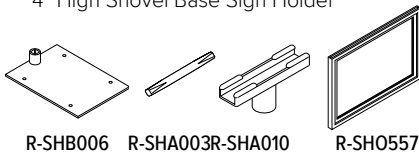

4" High Center Base Sign Holder



Shovel Base Sign Holder

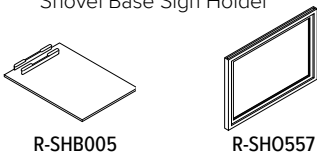

Wire Mount Sign Holder

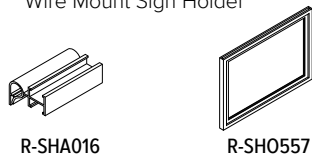

Large selection of components to create your ideal sign solution!



Plate Stem Mount for SuperGrip®

Add the power and flexibility of Fast-Gripz sign holders to modular stem components. Available in 3" x 1.25", and 3" x .5" sizes, its clear construction minimizes visual distraction.



SIGN HOLDERS



Modular Sign Frames

- Compatible with industry standard sign sizes.
- Dimensions listed below denote the size of the sign that the frame is designed to hold.
- High impact polystyrene construction with mitered edge finish.
- Can be used horizontally or vertically.
- Standard colors are white (W), black (K), and red (R).
- See website for additional colors

White (W)
 Black (K)
 Red (R)
 Specify color when ordering.

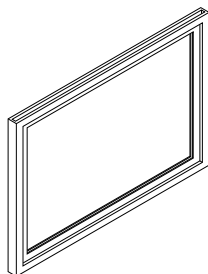

R-SHO_

Item No.	Ref. No.	Dimensions	Finish	Pack
3709343405	R-SHO355K-5	3.5" x 5.5"	Black	10
3706617531	R-SHO557K-7	5.5" X 7"	Black	10
3702536681	R-SHO557W-7	5.5" X 7"	White	10
3706659565	R-SHO711K-11	7" X 11"	Black	10
3708423816	R-SHO711W-11	7" X 11"	White	10
3706774602	R-SHO851K-85	8.5" X 11"	Black	10
3700306775	R-SHO851R-85	8.5" X 11"	Red	10
3705812535	R-SHO851W-85	8.5" X 11"	White	10
3700850613	R-SHO114K-14	11" X 14"	Black	10

Modular Sign Components

Flat Bases
3704079168

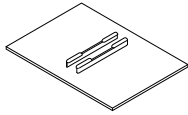

- For tables, counters, shelves, and other flat surfaces.
- 4.5" x 5.5"

Center Stem Bases
3705275902

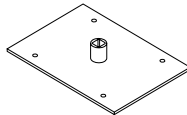

- Balanced center design for stand alone displays.
- 4.5" x 5.5"

Stem Shovel Bases
3704219339

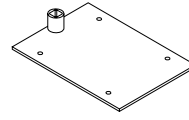

- Shovel design to hide sign holder base under product
- 4.5" x 5.5"

Magnetic Bases
3708830520

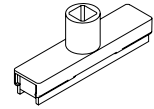

- Exceptional 14 lb. holding power on metal shelving and racks.
- 3" L x 1.25" H x .625" W

Magnetic Mount

3708946144

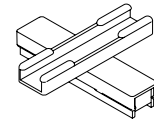

- Exceptional 14 lb. holding power for side, top or bottom mounting.
- 3" x 3" x 1" H

White (W)

Black (K)

Red (R)

Specify color when ordering.

Item No.	Ref. No.	Style	Dimensions	Finish	Pack
Bases					
3701096401	-	Sign Frame Magnetic Base	3"W x 1.25"H x .625"D	White	10
3701096402	-	Sign Frame Magnetic Base	3"W x 1.25"H x .625"D	Black	10
3708946144	R-SHA028	-	3"W x 3"H x 1"D	Clear	10
3706128939	R-SHB001K	Flat Base	4.5" x 5.5"	Black	10
3704079168	R-SHB001W	Flat Base	4.5" x 5.5"	White	10
3703285726	R-SHB002K	Center Stem Base	4.5" x 5.5"	Black	10
3704204473	R-SHB002W	Center Stem Base	4.5" x 5.5"	White	10
3705937221	R-SHB005K	Flat Shovel Base	4.5" x 5.5"	Black	10
3705726370	R-SHB005W	Flat Shovel Base	4.5" x 5.5"	White	10
3704349395	R-SHB006K	Single Stem Shovel Base	4.5" x 5.5"	Black	10
3704219339	R-SHB006W	Single Stem Shovel Base	4.5" x 5.5"	White	10
3705863969	R-SHB006R	Single Stem Shovel Base	4.5" x 5.5"	Red	10
3708830520	R-SHB011	Straight Magnetic Base	3"L x .625"W x 1.25"H	Clear	10

4" & 8" Stems

R-SHA003_ R-SHA004_

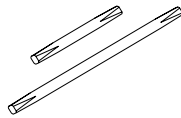

- Molded in high impact polystyrene.

Stem Mounts

3709675379

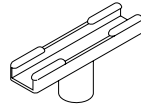

- For stems & sign holder bases
- 3" L x .375" W x 1.125" H
- 3704707860 holds .0095" .0285"

Stem Connector

R-SHA006_

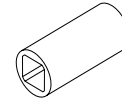

- Connects 4" or 8" polystyrene stems up to a maximum 16" length.
- 1.25" L x .5" W

Item No.	Ref. No.	Style	Dimensions	Finish	Pack
Stem and Stem Mounts					
3709269703	R-SHA003W	Stem	4" L x .375" dia.	Black	10
3701165649	R-SHA003R	Stem	4" L x .375" dia.	White	10
3707697874	R-SHA004K	Stem	8" L x .375" dia.	Black	10
3700561309	R-SHA004W	Stem	8" L x .375" dia.	Clear	10
3704398862	R-SHA006K	Stem Connector	1.5" L x .5" W	Black	10
3704146885	R-SHA006W	Stem Connector	1.5" L x .5" W	White	10
3709675379	R-SHA010	Stem Mount	3"L x .375"W x 1.125"H	Red	10
3708831259	R-SHA03125	Plate Stem Mount	.84"L x 3"W x 1.25"D	Black	10
3704049488	R-SHB014K	Gondola Center Stem	4.5"L x 2.875"W x 1.5"H	White	10
3708679802	-	Stem Mount	3.5"L	White	10

Plate Stem Mount for SuperGrip®

3708831259

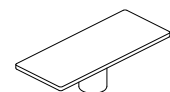

- For use with stems and sign holder bases.
- Ideal for use with SuperGrip® Sign Holders

Modular Sign Components

Slatwall Mounts
3703898975

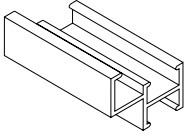

- For most slatwall installations.
- Molded in clear PVC.
- 2" L x 1" H x 1.125" W

90° Elbow
3704172608



- Use on 4" or 8" stems to rotate face of sign 90°.

All Purpose Clamp
3708378676

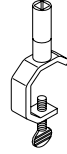

- Chrome Clamp for round and square stems - great all purpose clamp.
- Threaded stem adapter links clamp to the sign holders.

Wire Mounts
3708634625

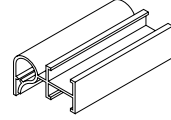

- For most standard wire bins and racking - clear PVC.
- 1" H x 1.25" W x 2" L

Price Channel Clips
3707263573

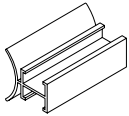

- Fits most 1.25" price channels.
- Great for shelf talkers.
- 1.25" H x 1.875" W

1" Saddle Clip Mounts
3701346120

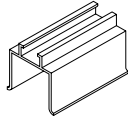

- For use on racks, gondolas and other fixtures.
- 1.5" H x 2" L x 1" W

Gondola Center Stems
3704049488

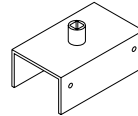

- For gondola tops.
- For use with 4" or 8" stems.
- Designed for 2.5" up-rights.

Basket/Carton Clip
3705017836

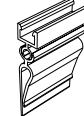

- Clips firmly to a variety of material thicknesses.
- 3" L x 4" H

SIGN HOLDERS

Item No.	Ref. No.	Dimensions	Finish	Pack
3703898975	R-SHA030	2" L x 1.125" W x 1" H	Clear	10
3707844967	R-SHA021	1.375" W x 1.375" H	Clear	10
3704172608	R-SHA011	5" W x 1" H x 1" D	Clear	10
3708378676	R-SHA025	2.625" H, 1.375 max clamp I.D.	Chrome	10
3708634625	R-SHA016	2" L x 1.25" W x 1" H	Clear	10
3707263573	R-SHA017	1.25" L x 1.875" H	Clear	10
3701346120	R-SHA012	2" L x 1" W x 1.5" H	Clear	10
3704049488	R-SHB014K	4.5" L x 2.875" W x 1.5" H	Black	10
3705017836	R-SHA038A	3" L x 4" H	Clear	10

White (W)

Black (K)

Red (R)

Specify color when ordering.

Plastic Sign Frame System

- Shovel base perfect for displaying signage on end caps and bulk merchandise displays, as well as flat surfaces
- Pre-drilled slots on base can be used with fasteners for attachment to metal perforated shelves or other fixtures
- Available in two styles: Shovel Base and Telescopic Shovel Base style is 8.25" H
- Telescopic style adjusts from 20" to 29" in overall height
- Accepts single- or double-sided graphics, 7" H x 11" W
- Black ABS

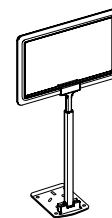

3701014801

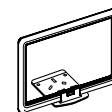

3701014802



Item No.	Ref. No.	Style	Finish	Pack
3701014801	-	Telescopic Shovel Base	Black	1
3701014802	-	Shovel Base	Black	1

Additional sizes and colors can be made to order (minimum quantities apply.)

Telescopic Plastic Sign Frame

- Telescopic sign frame adjusts from 12" to 22" high for use in displays throughout the store
- Sign frame features attractive rounded corners
- Stem can be raised or lowered with simple thumb release
- Stable round base is flat so it can slide beneath display products
- White plastic

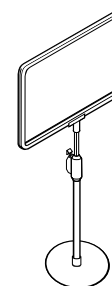

Item No.	Ref. No.	Dimensions	Finish	Pack
9920713839	-	11" W x 8.5" H	White	1

Additional sizes and colors can be made to order (minimum quantities apply.)

Standing Wedge

- Displays two signs back-to-back; ideal for end displays, table tops, and pallet displays
- Break-resistant, 4" clear plastic sign holder with flexible sign grip displays most sizes of paper or plastic signs
- Heavy-gauge black steel base stands freely
- Black metal stem is adjustable from 12" to 24" H

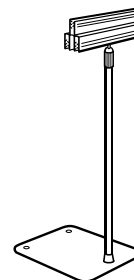

Item No.	Ref. No.	Dimensions	Finish	Pack
9920719627	-	4" L x 4.75" W Base	Black	1

Additional sizes and colors can be made to order (minimum quantities apply.)

Pallet Sign Holder

- 10" square base slips underneath display to hold it in place
- Height adjusts from 50" H to 70" H
- 9920713128 has Sign Frame that is 14" L x 11.125" H
- 9920710855 has Sign Frame and three-channel double-sided track extrusion; top track is 3.875" H, middle track is 5" H, bottom track is 1.75" H
- Black powder-coated steel



9920710855



9920713128



Item No.	Ref. No.	Style	Finish	Pack
9920713128	R16-APSH-K2BX	w/ Sign Frame	Black	1
9920710855	R16-11X85AHFSH	w/ Sign Frame and Extrusion	Black	1

Additional sizes and colors can be made to order (minimum quantities apply.)

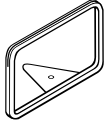

Chrome Sign Frame with Wedge Base

- Display pricing and promotional messages with durable chrome frame
- Wedge base beneath product on end caps or pallets, or display freestanding
- Metal

Item No.	Ref. No.	Dimensions	Finish	Pack
3709334303	R16-HUW-C	11" W x 7" H	Silver	1

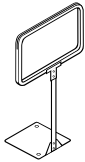

3703493302

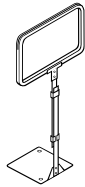

3702358702

Chrome Sign Frame with Stem

- Versatile sign frame can be used throughout the store
- Stable base can be used on flat surfaces or beneath product
- Available with fixed or adjustable stem
- Adjustable stem can be easily adjusted from 14"-22" L
- Metal

Item No.	Ref. No.	Stem	Dimensions	Pack
3703493302	R16-HRS-C	10" L Fixed Stem	11" W x 7" H	1
3702358702	-	14"-22" L Adj. Stem	11" W x 7" H	1

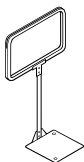

9920716618

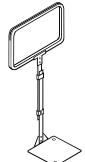

9920712144

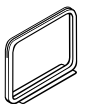

9920710660

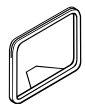

9920717452

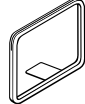

9920710008

Metal Sign Frames

- Metal sign frames are perfect for any department
- Heavy black powder-coating resists chipping
- Available in multiple sizes and styles
- Available with fixed or adjustable stem
- Metal

Item No.	Ref. No.	Style	Frame Dim.	Pack
9920712144	-	12"-24" Adj. Stem	11" H x 14" W	1
9920711122	-	12"-24" Adj. Stem	7" H x 11" W	1
9920716618	-	12" Fixed Stem	7" H x 11" W	1
9920718563	-	10" Fixed Stem	7" H x 11" W	1
9920710978	-	Magnetic Base	11" H x 14" W	1
9920710660	-	Magnetic Base	7" H x 11" W	1
9920717452	-	Wedge Base	7" H x 11" W	1
9920710008	-	Easel Base	11" H x 14" W	1

Additional sizes and colors can be made to order (minimum quantities apply.)

Indoor/Outdoor Front Load Metal Sign Frame

- Durable weather resistant frame provides an upscale look both indoors and outdoors
- 1" wide mitered frame opens to accept graphics up to .0625" thick and snaps shut with spring tension for a secure hold
- Clear plastic print overlay extends signage life
- Visible graphic area .75" less than listed sign size (below)
- Fully assembled; aluminum sign frame with back panel



Item No.	Ref. No.	Sign Dim.	Finish	Pack
3701134904	-	24" W x 36" H	Silver	1

Front Load Plastic Sign Frame

- Economical, durable 1" wide sign frame with attractive mitered corners
- Frame hinges open for easy sign placement, then snaps shut to hold signage securely
- Available with or without optional print overlay to prolong graphic life
- Visible graphic area .375" less than listed sign size (below)
- Wall-mount with included hardware (four screws and anchors)
- Mount to slatwall and pegboard with optional brackets (sold separately)
- Holds signs up to .060" thick
- Black or silver PVC with back panel



Item No.	Ref. No.	Sign Dim.	Finish	Pack
Sign Frame - Without Print Overlay				
3707215201	-	8.5" W x 11" H	Black	1
3707215205	-	22" W x 28" H	Black	1
3707215211	-	22" W x 28" H	Silver	1
3707215207	-	24" W x 36" H	Black	1
Sign Frame - With Print Overlay				
3705724205	-	22" W x 28" H	Black	1
3705724206	-	22" W x 28" H	Silver	1
3705724208	-	24" W x 36" H	Silver	1

Additional sizes and colors can be made to order (minimum quantities apply.)

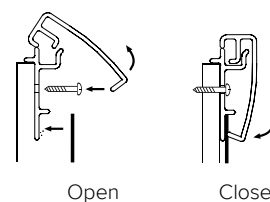

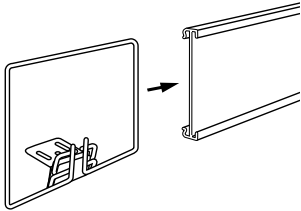

Flip Sign Holder with Metal Brackets

- Ideal for covering overstocks and cut cases, while providing a large signage area for maximum branding
- Hinging mechanism allows easy access for fast restocking; simply flip sign holder down and set shelf
- Shelf-Top Overhang style covers shelf edge 1.5"
- Attach to perforated shelves using Wing Nut and Bolt (sold separately, below); Recommend 6 sets per sign, 3 per bracket, for most secure fit to gondola shelving
- Attach to warehouse racks and other non-perforated metal surfaces with self-tapping screws (not included)
- Attach to wooden shelving and pallets with wood screws not included)
- Holds graphics 7" H x 48" L; material up to .125" thick
- Black metal brackets / plastic sign channel

Item No.	Ref. No.	Style	Finish	Pack
9920719101	-	Shelf-Top Overhang	Black	1
8535553601	-	Wing Nut & Bolt	Black	1

Additional lengths and colors can be made to order (minimum quantities apply.)



Universal Gondola Header

- Universal kit includes all components necessary to create Shelf Mount or Gondola Upright Mount headers
- Shelf Mount header pivots to allow easy access to overstock items; fits most perforated shelves
- Gondola Upright Mount displays signs above most standard retail gondolas
- Create multiple in-line headers using additional kits
- Height adjusts in 1" increments to hold signs 9" to 15" H
- Holds rigid sign materials up to .09375" thick
- 48" L; includes all assembly and mounting hardware
- Black HIPS frame, ABS brackets

Item No.	Ref. No.	Dimensions	Finish	Pack
3801968705	-	9-15" H x 48" L	Black	1

Additional lengths and colors can be made to order (minimum quantities apply.)



new



Extendable Header System

- Kit includes left and right extendable header brackets, Christmas tree pins
- Easy to set-up – brackets install directly into gondola uprights without tools or fasteners
- Easy to adjust height – simple pin lock system (2"- 4")
- Easy to adjust depth – telescopes out using similar pin lock system (16"- 24")
- Re-useable

Item No.	Dimensions Min Ext	Dimensions Max Ext	Color	Pack
2150127401	18.25" H x 16.25" L	24.25" H x 21.2" W	Black	1

4' Overhead Sign Holder

- Fits on to 4 foot gondola with pegboard.
- Adjustable sign height: 8 inches to 16 inches.
- Holds rigid signs up to 3 mil thick.
- Attaches to standard pegboard perforations.
- Black finish.

Customizable features

- Color
- Depth
- Sign height adjustment
- Sign angle
- Pegboard bracket

Ships flat

- Reduced shipping cost.
- Reduced storage space.



Easy to adjust height to hold sign boards in place.

Item No.	Ref. No.	Dimensions	Finish	Pack
2157448778	R-OSH48	4' x 8-16" H	Black	2

Header Flip Clip™ for 1" Cross Bar

- Convert your existing gondola uprights into an attractive sign and valance display using the Header Flip Clips™ on crossbars.
- Two-sided adhesive pad is hinged on the clip and provides customized placement, allowing different sizes and shapes of signs to be displayed.
- Easy installation and use of Header Flip Clips on crossbars; you can configure the top of your gondola upright into an instant sign to promote and brand your products.



Utilize the crossbar header flip clip to conceal overstock items on top shelf.

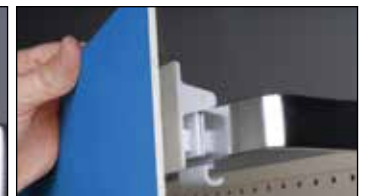
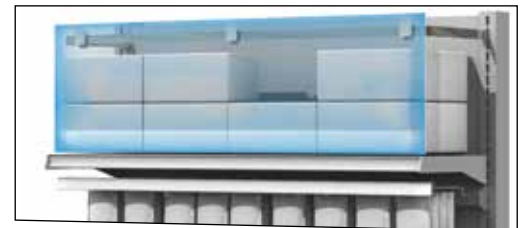

Item No.	Ref. No.	Dimensions	Finish	Pack
2151041482	RFHC-1502-W	1" W x 3" H	White	10



SuperGrip® Headers

- Four styles available, Gondola Upright, Pegboard, Slatwall and Warehouse Upright
- SuperGrip® grippers provide superior holding power
- End connectors are reversible; use two ends per sign
- Use center connectors for in-line signs
- Accepts rigid material .080" to .25" thick
- Easy assembly; ships bulk for freight savings
- Bracket also sold separately

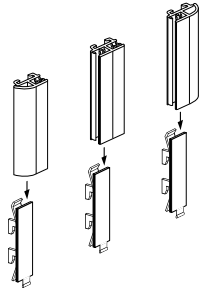

SuperGrip® Gondola Upright Header

- Fits most standard gondola upright slots .375" W x .75" H, 1" on center
- White ABS mount / clear PVC sign holder

Item No.	Ref. No.	Style	Dimensions	Pack
1512474702	-	End	8" L	1
1512474703	-	End	12" L	1
1519250603	-	Center	12" L	1

Additional lengths and colors can be made to order (minimum quantities apply.)

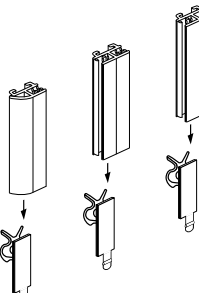

SuperGrip® Slatwall Header

- Fits most standard slatwall and can be repositioned
- Natural polypropylene mount / clear PVC sign holder

Item No.	Ref. No.	Style	Dimensions	Pack
1516288502	-	End	8" L	1

Additional lengths and colors can be made to order (minimum quantities apply.)

SuperGrip® Warehouse Upright Header

- Fits most standard warehouse uprights; repositionable
- White ABS mount / clear PVC sign holder
- See info under SuperGrip® Headers on the opposite page

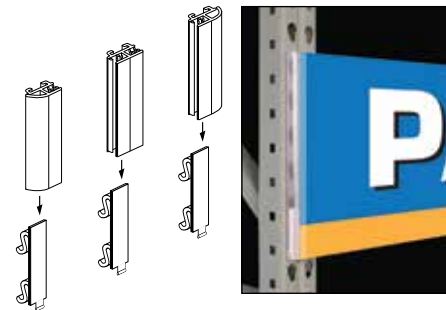

Item No.	Ref. No.	Style	Dimensions	Pack
1513283401	-	End	4" L	1

Additional lengths and colors can be made to order (minimum quantities apply.)

SuperGrip® Gondola Top Sign Holder

- Place signs on the top of a retail gondola without adhesive
- Easy to relocate
- SuperGrip® brand technology grips gondola and signs securely
- Holds signs from .1875" to .25" thick
- Clear PVC



SIGN HOLDERS

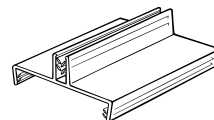

Item No.	Ref. No.	Dimensions	Finish	Pack
2116004501	-	2.75" W x 3" L	Clear	1
2116004502	RFG2-2496-6	2.75" W x 6" L	Clear	1

Additional lengths and colors can be made to order (minimum quantities apply.)

Gondola Sign Headers

- Provides an easy way to add signage to existing fixtures..
- Heat folded design allows for easy sign insertion and replacement for seasonal or promotional transitions.
- Frosted acrylic composition reduces glare and also allows for two-sided viewing.
- Mount onto the top of a gondola with the SuperGrip® Gondola Top Sign Holder (above) or mount to a smooth surface with two-sided tape.

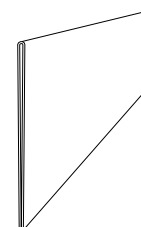

Item No.	Ref. No.	Dimensions	Finish	Pack
2203758165	RGH-8548F	48" W x 8.5" H	Clear	5



Spiral Sign Board System

- Display sign boards from most standard retail gondolas or ceilings
- Mount to gondolas with brackets (below) or hang from ceiling with ceiling display accessories
- Double-sided board holds signs spiral bound pads
- Holds 7.875" H signs in top channel, 11.125" H spiral pads in bottom channel
- Spiral pads feature a variety of printed characters and messages
- White polystyrene sign board
- Polystyrene spiral pads



Dollar Pad Contains:
0, 1, 2, 3, 4, 5, 6, 7, 8, 9, \$,
Blank (Black type)



Cent Pad Contains:
0, 1, 2, 3, 4, 5, 6, 7, 8, 9, ¢,
Blank (Black type)



Reading Pad Contains:
% off, From, For, Reg, Now, And
Up, After Rebate, Each, To,
Decimal, Arrow, Blank (Black type)

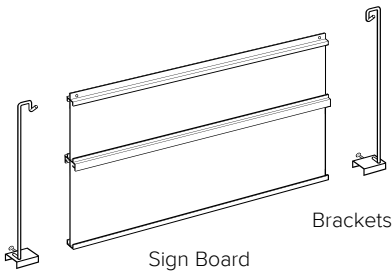

Item No.	Ref. No.	Style	Dimensions	Pack
3800152600	R-SSB-20X34	Sign Board	20.375" H x 34" W	1
3803781862	R72-23SSBH-W	Brackets	22" H	2
3800301000	R-SSP-11D	Dollar Pad	11.125" H x 5.30" W	1
3800301100	R-SSP-11C	Cent Pad	11.125" H x 3" W	1
3800301200	R-SSP-11R	Reading Pad	11.125" H x 3" W	1

Additional sizes and colors can be made to order (minimum quantities apply.)

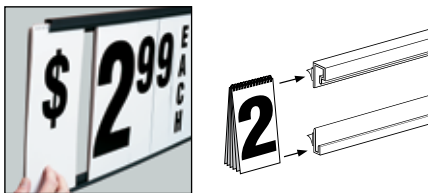

Spiral Sign Holder

- Displays pads and signage of nearly any height for a versatile solution
- Side-access ensures quick and easy pad placement and replacement
- Attaches with permanent adhesive for long life
- 2-piece break-away design
- Holds pads up to .125" thick, with spiral diameter of .375"
- Shown with Spiral Pads (above)
- Available in four sizes
- White or black PVC

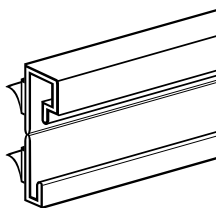

Item No.	Ref. No.	Dimensions	Finish	Pack
4302870803	-	17" L	White	1
4302870805	-	24" L	White	1
4302870801	-	48" L	White	1
4302870802	-	48" L	Black	1

Additional lengths and colors can be made to order (minimum quantities apply.)

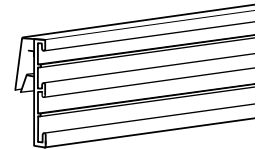
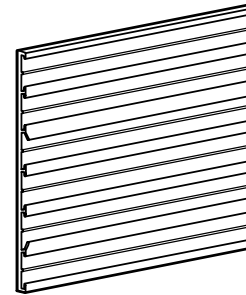
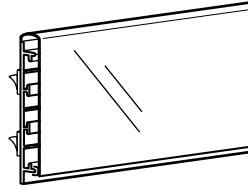
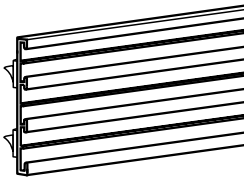

9920713682

9920719164

9920715495

9920719611

Self-Adhesive Track Sign Channel

- 2- and 3-channel tracks hold names and strip numbers
- Adhesive-backed to mount to most flat surfaces
- Each track is 1.25" H
- Black plastic

Self-Adhesive Track Sign Channel with Clear Cover

- 2- and 3-channel tracks have a clear, hinged cover to help protect the signage
- Two strips of foam tape allow the track to be applied to any clean surface
- Each track is 1.25" H
- Black plastic with clear cover

Six-Track Sign Channel

- Six-Track sign channel displays a variety of signage
- Each track is 1.25" H
- Integrated topper slot holds promotional signs
- Attach using adhesive tape, magnetic tape, or self-tapping screws (sold separately)
- Black plastic

Clip-On Track Sign Channel

- Clip-onto multi-deck shelving
- 2-Track or 3-Track
- Track hooks onto shelf product stop for a consistent, uniform look
- Each track is 1.25" H
- Black plastic

SIGN HOLDERS

Item No.	Ref. No.	Style	Dimensions	Pack
Self-Adhesive Track Sign Channel				
9920710869	-	2-Track	2.5" H x 48" L	1
9920713682	-	3-Track	4" H x 48" L	1
Self-Adhesive Track Sign Channel with Clear Cover				
9920719063	-	2-Track	2.5" H x 48" L	1
9920719164	-	3-Track	3.75" H x 48" L	1
Six-Track Sign Channel				
9920715495	-	6-Track	8" H x 48" L	1
Clip-On Track Sign Channel				
9920719611	-	2-Track	3" H x 48" L	1
9920710622	-	3-Track	4" H x 48" L	1

Additional sizes and colors can be made to order (minimum quantities apply.)

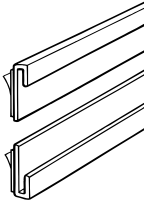

4308078233

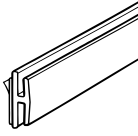

4301836533

J-Channel and H-Channel

J-Channel

- Use with H-Channel to display multiple signs
- Secures in place with permanent white foam adhesive or clear tape adhesive
- Holds material up to .25" thick
- 48" length
- White or black polystyrene or clear PETG or PVC

H-Channel

- Use with J-Channel to create custom displays
- Secured with permanent white foam adhesive or clear tape adhesive
- Holds material up to .060" thick
- 48" length
- White or black polystyrene or clear PETG or PVC

Item No.	Ref. No.	Capacity	Finish	Material	Adhesive	Pack
J-Channel						
4308078201	-	.060"	Clear	PETG	Foam	1
4308078241	RJCH-48PVF060C	.060"	Clear	PVC	Foam	1
4308078275	-	.060"	Clear	PVC	Tape	1
4308078202	-	.060"	White	Polystyrene	Foam	1
4308078233	-	.060"	Black	Polystyrene	Foam	1
4308078274	-	.060"	Black	Polystyrene	Tape	1
4301665601	-	.125"	Clear	PETG	Foam	1
4301665641	RJCH-48PVF125C	.125"	Clear	PVC	Foam	1
4301665602	-	.125"	White	Polystyrene	Foam	1
4301665633	-	.125"	Black	Polystyrene	Foam	1
4308183701	-	.25"	Clear	PETG	Foam	1
4308183741	RJCH-48PVF250C	.25"	Clear	PVC	Foam	1
4308183733	-	.25"	Black	Polystyrene	Foam	1
H-Channel						
4301836501	-	.060"	Clear	PETG	Foam	1
4301836541	RHCH-48PVF060C	.060"	Clear	PVC	Foam	1
4301836575	-	.060"	Clear	PVC	Tape	1
4301836502	-	.060"	White	Polystyrene	Foam	1
4301836533	-	.060"	Black	Polystyrene	Foam	1
4301836574	-	.060"	Black	Polystyrene	Tape	1

Additional lengths and colors can be made to order (minimum quantities apply.)

Econo C-Channel

- Economical C-Channel holds 1.25" H signs, tickets and tags
- Attach with permanent transparent adhesive
- Thinner profile than CHC C-Channels
- Channel Insert Strips are available in multiple colors
- White or black polystyrene

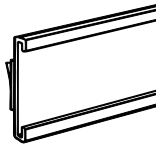

Item No.	Ref. No.	Dimensions	Finish	Pack
4305867801	-	1.25" H x 48" L	White	1
4305867803	-	1.25" H x 48" L	Black	1

Additional lengths and colors can be made to order (minimum quantities apply.)

C-Channel

- Open-face holder for 1.25" H, 3" H or 5" H signs, tickets and tags
- Available with or without permanent foam adhesive
- 9920711201 has clear adhesive tape
- White or black polystyrene or clear PETG



2" H and 7" H with adhesive

SIGN HOLDERS

Item No.	Ref. No.	Dimensions	Style	Finish	Pack
4301780119	-	1.25" H x 48" L	w/ adh	White	1
4301780121	-	1.25" H x 48" L	w/ adh	Clear	1
4301780122	-	1.25" H x 48" L	w/o adh	Clear	1
4301780133	-	1.25" H x 48" L	w/ adh	Black	1
9920711201	-	1.25" H x 48" L	w/ adh	Clear	1
4308048908	-	3" H x 48" L	w/ adh	White	1
4308048910	-	3" H x 48" L	w/ adh	Clear	1
4308048950	-	5" H x 48" L	w/ adh	Clear	1

Additional lengths and colors can be made to order (minimum quantities apply.)

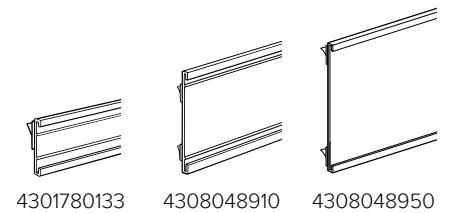

C-Channel with Integrated Slot

- Open-face holder for 1.25" H signs, tickets or tags
- Integrated slot in the top allows for promotional signage to be added
- Attach with permanent foam tape
- Black PVC

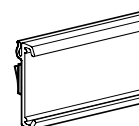

Item No.	Ref. No.	Dimensions	Finish	Pack
4307192801	-	1.25" H x 48" L	Black	1



RAZZ® System

The original one-size-fits-all sign holder system capable of holding materials up to .25" thick. Accommodates die-cut or traditional square-cut signs of many shapes and sizes. Easy to use and easy to see. Multiple base styles allow you to display signs on almost any flat surface: gondola tops, fixtures, counter tops. In fact, just about anywhere you can think of. Jazz up your signs with the RAZZ® System!

An easy-to-use sign system

1. Choose any Base style
2. Select Channel design depending on the thickness of the sign material you're using
3. Insert the Channel into the Base and slide your sign into the channel

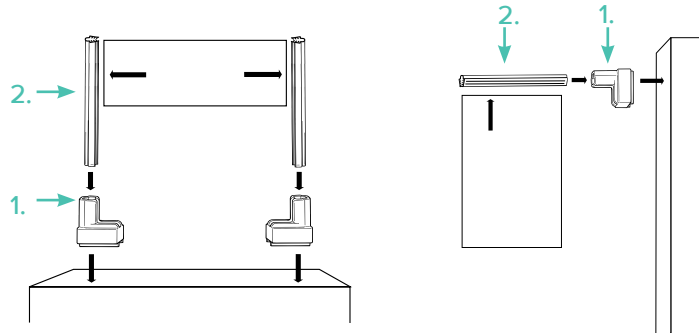

RAZZ® with channels



RAZZ® without channels



RAZZ® on warehouse racks



RAZZ® on top of coolers

SIGN HOLDERS

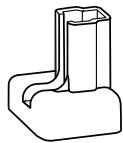

Bases

RAZZ® System Contoured Magnetic Base

- Attaches securely to most metal surfaces
- Black, white or beige ABS with high-strength magnet
- **WARNING:** Do not use near sensitive electronic equipment

Item No.	Ref. No.	Finish	Pack
2007299201	-	White	1
2007299202	-	Black	1
2007299203	-	Beige	1

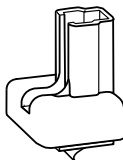

RAZZ® System Contoured Adhesive Base

- Attaches securely to nearly any clean, flat surface with permanent adhesive
- Foam tape aids in adhesion to rough surfaces
- Black or white ABS
- Assembled



Item No.	Ref. No.	Finish	Pack
2007299207	-	White	1
2007299208	-	Black	1

RAZZ® System Magnetic Base

- Clear base offers an unobstructed view of graphics
- Attaches securely to most metal surfaces
- Black, white or clear ABS with high-strength magnet
- **WARNING:** Do not use near sensitive electronic equipment

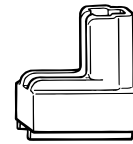

Item No.	Ref. No.	Finish	Pack
2007585703	-	White	1
2007585704	-	Black	1
2007585760	-	Clear	1

RAZZ® System Freestanding Adhesive Base

- Adheres securely to any clean, flat surface with permanent adhesive
- Also available without adhesive
- Black or white ABS / clear PVC
- Assembled

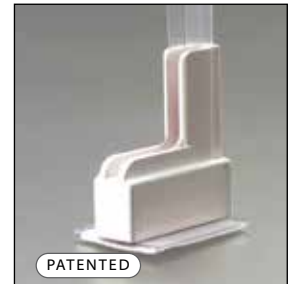
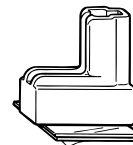

Item No.	Ref. No.	Finish	Pack
2007585709	-	White	1
2007585710	-	Black	1

RAZZ® System Gondola Top Base

- Holds signs centered on top of standard 2.5" wide gondolas
- Attaches with SuperGrip® holding power
- Black or white ABS / clear PVC
- Assembled

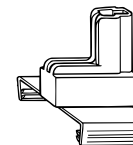

Item No.	Ref. No.	Finish	Pack
2007585707	-	White	1
2007585708	-	Black	1

Channels

RAZZ® System SuperGrip® Channel

- Provides SuperGrip® brand holding power
- Holds signs .125" to .25" thick
- Clear PVC

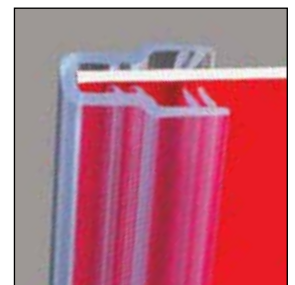

Item No.	Ref. No.	Dimensions	Pack
2007818501	-	12" L	1
2007818502	-	18" L	1
2007818551	-	24" L	1
2007818552	-	36" L	1

RAZZ® System Thin Poster Channel

- Reverse flanges provide secure fit
- Holds materials up to .125" thick
- Clear PVC

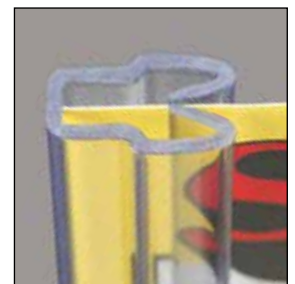

Item No.	Ref. No.	Dimensions	Pack
2007647502	-	12" L	1
2007647503	-	18" L	1
2007647551	-	24" L	1

Additional lengths and colors can be made to order for RAZZ® System Bases and Channels (minimum quantities apply.)

SIGN HOLDERS



Insta-Flag™ Sign System

A very simple sign system with considerable flexibility in positioning signs for maximum appeal and visibility.

Display tubes fit onto a variety of bases, allowing you to hang signs from different surfaces and at different angles. Signs slide into tubes. Nothing could be easier or faster than Insta-Flag™.

An easy-to-use sign system

1. Pick any Display Tube
2. Select any Display Base
3. Create a flag



Insta-Flag™ for shelf channel



Insta-Flag™ with adhesive



Insta-Flag™ for slatwall



Display Tubes

SuperGrip® Display Tube

- SuperGrip® brand technology for maximum holding power
- Fits all Insta-Flag™ Display Bases
- Available in 12" and 24" lengths
- White PVC

Item No.	Ref. No.	Dimensions	Finish	Pack
2501807701	-	12" L	White	1

Additional lengths can be made to order (minimum quantities apply.)

Display Bases

Angled Display Base 2293

- Holds Insta-Flag™ Display Tubes in the 30° angled flag position
- Fits most 1.25" shelf channels
- Available with adhesive for flat surfaces
- Shown with SuperGrip® Display Tube
- White polypropylene

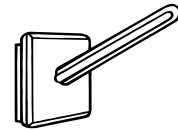
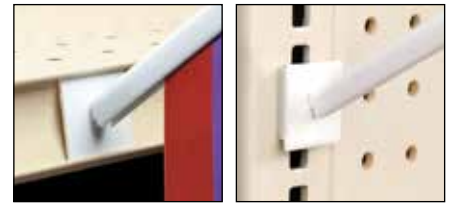

Item No.	Ref. No.	Style	Finish	Pack
2502089601	-	w/o adhesive	White	1
2502089602	-	w/ adhesive	White	1

Magnetic Adapter CH-10

- Allows you to add Insta-Flag™ Sign System to most metal surfaces
- Versatile rubber magnet with nickel housing for use on metal surfaces and shelving
- Features integrated center hole; 3" L housing available with 2 magnets, or 3 magnets for strongest hold
- Use with Angled Display Base (above)
- Nickel housing
- **WARNING:** Do not use near sensitive electronic equipment

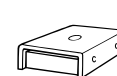

8607554201

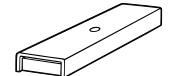

8607460001

SIGN HOLDERS

Item No.	Ref. No.	Dimensions	Magnets	Pack
8607554201	-	1" L	1	1
8607460004	-	3" L	2	1
8607460001	-	3" L	3	1

Additional sizes can be made to order (minimum quantities apply.)

Slatwall Adapter

- Holds Insta-Flag™ Display Bases
- Fits all standard slatwall grooves
- White polystyrene

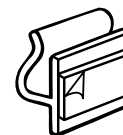

Item No.	Ref. No.	Dimensions	Finish	Pack
2501687002	RSAD-001-1	1" L	White	1

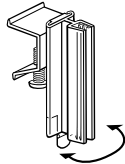

0112465201

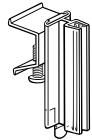

0110869802

SuperGrip® Channel Mount Sign Holder

- Add aisle signage to shelf channels
- SuperGrip® technology provides superior holding power
- Use two holders to support blade signs from shelf to shelf
- Available with or without hinge; hinge allows signs to flex
- Fits most 1.25" shelf channels; comes with a Phillips head machine screw for secure fit
- 3" L, two capacities hold material up to .100", or .100"-.250" thick
- Beige ABS / clear PVC
- Assembled

Item No.	Ref. No.	Style	Capacity	Pack
0112465201	-	w/ hinge	.100"	1
0112465202	-	w/ hinge	.100"-.250"	1
0110869801	-	w/o hinge	.100"	1
0110869802	-	w/o hinge	.100"-.250"	1

Additional lengths and colors can be made to order (minimum quantities apply.)

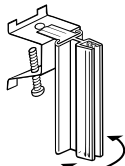
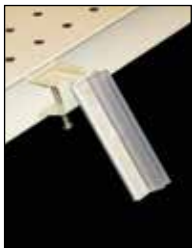

0210000000

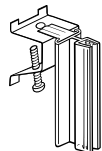

0210000100

SuperGrip® Metal Channel Mount Sign Holder

- Securely mount aisle signage to shelf channels with durable metal bracket
- SuperGrip® technology provides superior holding power
- Available with or without hinge; hinge allows signs to flex for safety
- Fits most 1.25" H shelf channels; comes with Phillips head machine screw for secure fit
- 3" L, two capacities hold material up to .100" thick, or .100"-.250" thick
- Beige powder-coated metal mount / clear PVC sign holder

Item No.	Ref. No.	Style	Capacity	Pack
0210000000	-	w/ hinge	.100"	1
0210000100	-	w/o hinge	.100"	1

Additional lengths and colors can be made to order (minimum quantities apply.)

SuperGrip® Under-Shelf Spring-Mount Sign Holder

- Spring steel mount adds shelf-edge signage without interfering with product or shelf management systems
- SuperGrip® technology provides superior holding power
- Use two holders to support blade signs from shelf to shelf
- Available with or without hinge; hinge allows signs to flex when bumped
- Fits most standard perforated shelves; spring steel mount flexes so tabs clip securely into perforated shelf holes
- Included optional locking screw secures sign holder to shelf
- 3" L, two capacities hold materials up to .100", or .100"-.250" thick
- Beige powder-coated metal mount / clear PVC sign holder
- Assembled

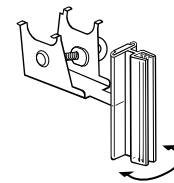

1810784501

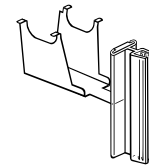

1815245602



Item No.	Ref. No.	Style	Capacity	Pack
With Hinge				
1810784501	RPM-21-A	w/ screw	.100"	1
1810784502	-	w/ screw	.100"-.250"	1
1813721601	-	w/o screw	.100"	1
1813721602	-	w/o screw	.100"-.250"	1
Without Hinge				
1815245601	-	w/o screw	.100"	1
1815245602	-	w/o screw	.100"-.250"	1

Additional lengths and colors can be made to order (minimum quantities apply.)

SuperGrip® Under-Shelf Mount Sign Holder

- Use two holders to support blade signs from shelf to shelf
- Hinge allows signs to flex
- Fits most perforated shelves using included wing nuts and bolts
- 3" L, two capacities hold material up to .100", or .100"-.250" thick
- Beige powder-coated metal / clear PVC
- Sign holder and bracket assembled; wing nuts and bolts packed bulk

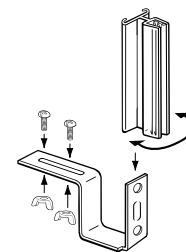

1817603600



Item No.	Ref. No.	Style	Capacity	Pack
1817603600	R-UMSH-3	w/ hinge	.100"	1
1817603601	-	w/ hinge	.100"-.250"	1

Additional lengths and colors can be made to order (minimum quantities apply.)

SIGN HOLDERS

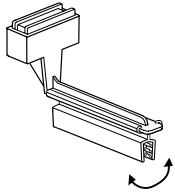

1812964901

Magnetic Under-Shelf Mount Sign Holder L-Style

- Compatible with open-air coolers to add signs in the flag position
- SuperGrip® technology provides superior holding power
- Heavy-duty magnetic strength for extra holding power
- Sign Holder hinge allows signs to flex when bumped
- 4" L, two capacities to hold material up to .100", or .100"-.250" thick
- Black or beige ABS mount with magnetic base / clear
- PVC sign holder
- Assembled

Item No.	Ref. No.	Style	Capacity	Finish	Pack
1812964901	-	w/ hinge	.100"	Beige	1
1812964911	-	w/ hinge	.100"	Black	1
1812964902	-	w/ hinge	.100"-.250"	Beige	1
1812964912	-	w/ hinge	.100"-.250"	Black	1

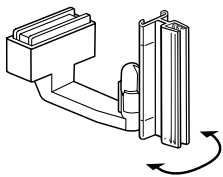

1816255308

Magnetic Under-Shelf Mount Sign Holder with Swivel

- Allows you to add signs in the flag position by attaching securely to most metal surfaces with heavy-duty magnet
- Bracket swivels to allow signs to flex when bumped
- SuperGrip® technology provides superior holding power; integrated screw can be adjusted to improve fit of Sign Holders/Adapters
- Sign Holder available with or without hinge
- 3" L, two capacities to hold material up to .100", or .100"-.250" thick
- Black or beige ABS mount with magnetic base / clear
- PVC sign holder
- Assembled

Item No.	Ref. No.	Style	Capacity	Finish	Pack
1816255308	-	w/ hinge	.100"	Beige	1
1816255305	-	w/ hinge	.100"	Black	1
1816255302	-	w/ hinge	.100"-.250"	Beige	1
1816255306	-	w/ hinge	.100"-.250"	Black	1
1816255301	-	w/o hinge	.100"	Beige	1

SuperGrip® Shelf-Top Sign Holder – Metal

- Low profile metal plate doesn't interfere with products on shelf or shelf management systems
- SuperGrip® technology provides secure hold
- Available with or without hinge; integrated hinge flexes for customer safety
- Fits most standard perforated shelves
- 3" L, two capacities hold material up to .100", or .100"-.250" thick
- Beige powder-coated metal / clear PVC
- Assembled

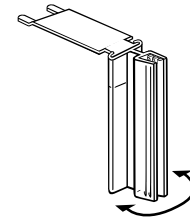

7909128402

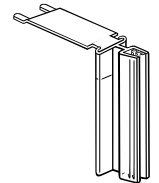

1810514902

Item No.	Ref. No.	Style	Capacity	Pack
7909128402	-	w/ hinge	.100"	1
7909128403	-	w/ hinge	.100"-.250"	1
1810514901	-	w/o hinge	.100"	1
1810514902	-	w/o hinge	.100"-.250"	1

Additional lengths and colors can be made to order (minimum quantities apply.)

SuperGrip® Shelf-Top Sign Holder

- SuperGrip® brand technology provides superior holding power
- Use two holders to support blade signs from shelf to shelf
- Available with or without hinge; hinge allows signs to flex when bumped
- Fits most perforated shelves, repositionable
- 3" L, two capacities hold material up to .100", or .100"-.250" thick
- Beige glass-filled nylon / clear PVC
- Assembled

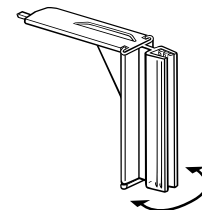

1817663001

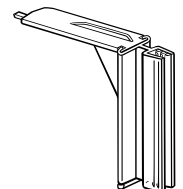

1818429902

Item No.	Ref. No.	Style	Capacity	Pack
1817663001	-	w/ hinge	.100"	1
1817663003	-	w/ hinge	.100"-.250"	1
1818429901	-	w/o hinge	.100"	1
1818429902	-	w/o hinge	.100"-.250"	1

Additional lengths and colors can be made to order (minimum quantities apply.)

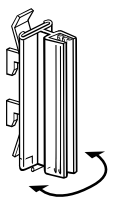

1515488801

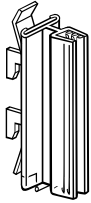

1514868702

SuperGrip® Gondola Upright Sign Holder

- Display signage from gondola uprights to capture attention
- Use two holders to support long blade signs
- Available with or without hinge; hinge allows signs to flex when bumped
- Fits most standard gondola upright slots .375" wide x .75" tall, 1" on center
- 3" L, two capacities hold materials up to .100", or .100"-.250" thick
- Beige ABS mount / clear PVC sign holder
- Assembled

Item No.	Ref. No.	Style	Capacity	Pack
1515488801	-	w/ hinge	.100"	1
1514868701	-	w/o hinge	.100"	1
1514868702	-	w/o hinge	.100"-.250"	1

Additional lengths and colors can be made to order (minimum quantities apply.)

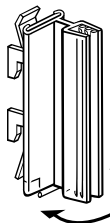

1516080901

SuperGrip® Gondola Upright Offset Sign Holder

- Display signage from gondola uprights without interfering with shelves
- Ideal for end cap displays
- SuperGrip® technology provides superior holding power
- Fits most standard gondola uprights
- Beige ABS mount / clear PVC sign holder
- Unassembled

Item No.	Ref. No.	Style	Capacity	Pack
1516080901	-	w/ hinge	.100"	1
1516080902	-	w/ hinge	.100"-.250"	1

Additional lengths and colors can be made to order (minimum quantities apply.)

SuperGrip® Pegboard Sign Holder

- Add aisle signage to standard pegboard
- Available with or without hinge; hinge allows signs to flex when bumped
- Use two holders to support large blade signs
- Fits most standard pegboard and can be repositioned
- 3" L, two capacities hold material up to .100", or .100"-.250" thick
- White ABS / clear PVC
- Assembled

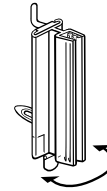
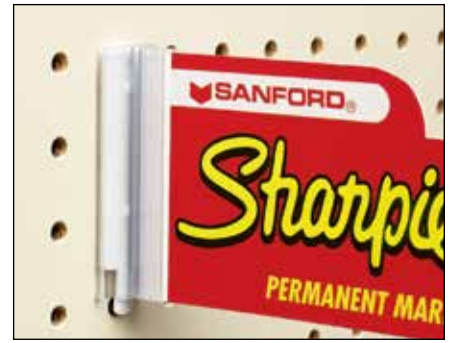

2117342601

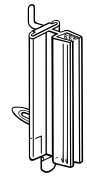

2114491102

Item No.	Ref. No.	Style	Capacity	Pack
2117342601	-	w/ hinge	.100"	1
2117342602	-	w/ hinge	.100"-.250"	1
2114491101	-	w/o hinge	.100"	1
2114491102	-	w/o hinge	.100"-.250"	1

Additional lengths and colors can be made to order (minimum quantities apply.)

SuperGrip® Warehouse Upright Sign Holder Teardrop Hole

- Available with or without hinge; hinge enables sign to flex when bumped
- Fits into most standard warehouse uprights and can be repositioned
- SuperGrip® brand technology provides superior holding power
- 3" L, two capacities hold material up to .100", or .100"-.250" thick
- White ABS / clear PVC
- Assembled

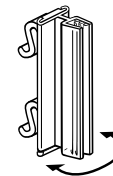

211898802

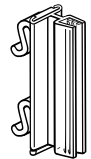

2118389602

Item No.	Ref. No.	Style	Capacity	Pack
211898802	-	w/ hinge	.100"	1
211898803	-	w/ hinge	.100"-.250"	1
2118389601	-	w/o hinge	.100"	1
2118389602	-	w/o hinge	.100"-.250"	1

Additional lengths and colors can be made to order (minimum quantities apply.)

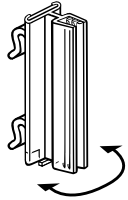
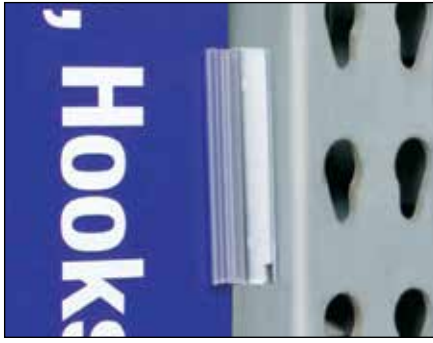

2115247901



2114270801

SuperGrip® Warehouse Upright Sign Holder Square Hole

- Add aisle or promotional signage to warehouse uprights
- Available with or without hinge; hinge enables signs to flex when bumped
- Fits into most standard warehouse upright square holes and can be repositioned
- Use two holders to support large blade signs
- SuperGrip® brand technology provides superior holding power
- 3" L, two capacities hold material up to .100", or .100"-.250" thick
- White ABS / clear PVC
- Assembled

Item No.	Ref. No.	Style	Capacity	Pack
2115247901	RFG2-WU-H100	w/ hinge	.100"	1
2115247902	RFG2-WU-H250	w/ hinge	.100"-.250"	1
2114270801	RFG2-WU-NH100	w/o hinge	.100"	1
2114270802	RFG2-WU-NH250	w/o hinge	.100"-.250"	1

Additional lengths and colors can be made to order (minimum quantities apply.)

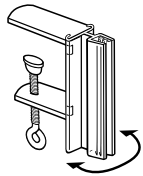

1816686801

SuperGrip® Aisle Sign Holder with C-Clamp

- Add flag aisle signage to square edge shelves or other fixtures
- Hinge allows sign holder to flex when sign is bumped
- C-Clamp allows maximum placement flexibility for use throughout the store
- Fits shelves or other fixtures up to 1.5" thick
- Two capacities hold material up to .100", or .100"-.250" thick
- C-Clamp size: 2" H x .75" W x 2" D; SuperGrip® sign holder is 3" L
- Zinc-plated metal C-Clamp / clear PVC sign holder
- Assembled

Item No.	Ref. No.	Style	Capacity	Pack
1816686801	-	w/ hinge	.100"	1
1816686802	-	w/ hinge	.100"-.250"	1

Additional colors can be made to order (minimum quantities apply.)

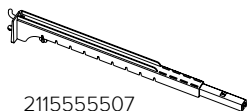

2115555507

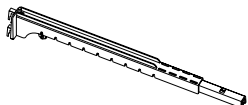

SuperGrip® Telescopic Aisle Sign Holder

- Extend signage into aisle to capture customer attention
- SuperGrip® brand holding power
- Telescoping arm easily adjusts from 16" to 24" L in 1" increments
- Gondola upright style fits Lozier, Darling and Madix brand gondolas
- Holds material up to .125" thick
- Sign holder insert: 8.375" L
- Beige high-impact plastic
- Unassembled

Item No.	Ref. No.	Style	Finish	Pack
2115555500	-	Gondola Upright	Beige	1
2115555507	-	Pegboard	Beige	1

Additional colors can be made to order. Additional mounting adapters can be made to order for other applications (minimum quantity and lead times apply.)

SuperGrip® Telescopic Aisle Sign Holder – Metal

- Securely display aisle signage for maximum visibility
- Hinge allows sign to flex when bumped SuperGrip® brand holding power
- Use two holders to support large blade signs
- Telescoping arm easily adjusts from 13” to 21” L in 1” increments
- Tool-Free style can be installed without a screwdriver
- 3” L sign holder; holds material up to .100” thick
- Powder-coated metal / clear PVC
- Assembled

Item No.	Ref. No.	Style	Fits	Pack
211444401	-	w/ hinge	Beige, Gondola Upright	1
211444421	-	w/ hinge	Beige, Gondola Upright – Tool-Free	1
211777701	RMA-1321PA	w/ hinge	Beige, Pegboard	1
2154285141	RMA-1321PK	w/ hinge	Black, Pegboard	2
2119164001	RMA-1321UA	w/o hinge	Beige, Gondola Upright	1
2155586919	RMA-1321UK	w/o hinge	Black, Gondola Upright	2
2119164021	-	w/o hinge	Beige, Gondola Upright – Tool-Free	1
2117385301	-	w/o hinge	Beige, Pegboard	1

Additional colors can be made to order (minimum quantities apply.)

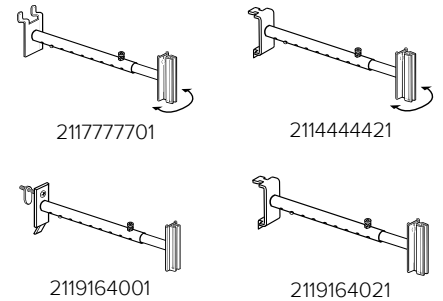

Telescopic Hanging Sign Holder

- Capture customer attention with aisle signage
- Telescoping arm easily adjusts from 13” to 21” L in 1” increments
- Adjustable hooks fit signs with hanging holes 1” to 10” W apart
- Holds signs up to .375” thick; signs require minimum .125” diameter hanging holes
- Beige powder-coated metal

Item No.	Ref. No.	Style	Finish	Pack
1508563201	-	Gondola Upright	Beige	1
1502544101	-	Pegboard	Beige	1

Additional colors can be made to order (minimum quantities apply.)

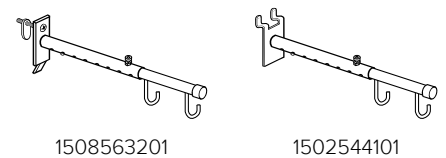

Metal Telescopic Bracket

- 3” H x 3/4” W mounting area; one 3/16” diameter hole
- Telescoping arm easily adjusts from 13” to 21” L in 1” increments (2114441600 telescopes 16” to 24” L)
- Tool-free style can be installed without a screwdriver
- Compatible with any of the Sign Holders/Adapters (pages 208-210)
- Attach displays to mounting plate using Adhesive Pads, fasteners or tack welding
- Can also slide displays onto mounting plate (1/16” capacity)
- Beige powder-coated metal

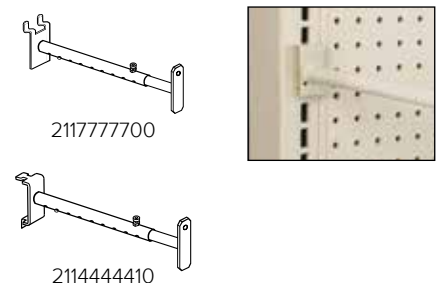

Item No.	Ref. No.	Style	Telescopes	Pack
211777700	-	Pegboard	13” - 21” L	1
211444410	-	Gondola Upright – Tool-Free	13” - 21” L	1
2114441600	-	Gondola Upright	16” - 24” L	1
2114441610	-	Gondola Upright – Tool-Free	16” - 24” L	1

SIGN HOLDERS

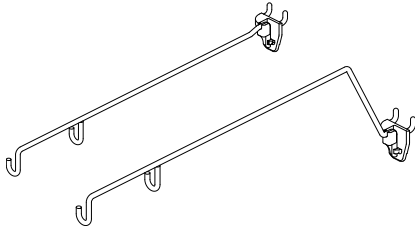
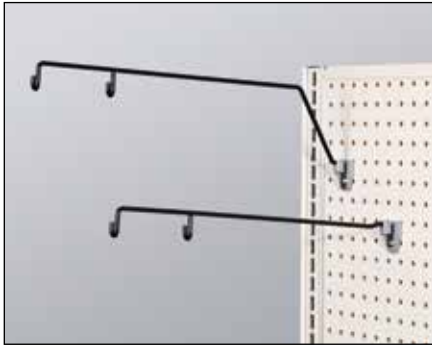

Fastback® Aisle Sign Hangers - Straight and Angled

- Ideal for placement of product location signs and promotional or informational signs.
- 2-piece Fastback® design for easy placement on pegboard or slatwall.
- Straight version (RFAV-S16-K) is 16" L,
- Angled version (RFAV-A18-K) is 18" L.
- Uses .212" diameter wire.
- Sign hooks are 4" on center.
- Stock color is black. Custom colors available.

Item No.	Ref. No.	Dimensions	Finish	Pack
2157331293	RFAV-S16-K	16" L x .212" Dia.	Black	10
2156752872	RFAV-A18-K	18" L x .212" Dia.	Black	10

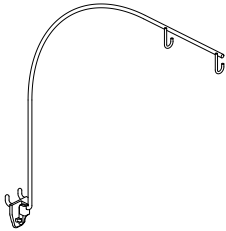
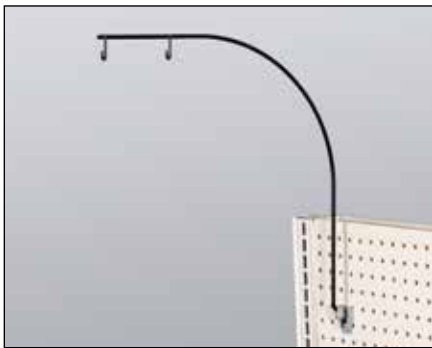

Fastback® Aisle Sign Hangers - Curved

- Ideal for placement of product location signs.
- 2-piece, Fastback® design for easy placement on pegboard or slatwall.
- Sign hanger extends 16" H and 16" D.
- Uses .212" diameter wire.
- Sign hooks are 4" on center.
- Stock color is black. Custom colors available.

Item No.	Ref. No.	Dimensions	Finish	Pack
2153660900	RFAV-C16-K	16" L x 16" H x .212" Dia.	Black	10

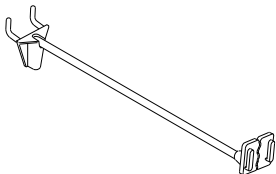

Multi-Fit Peg-Tag™ Sign Holders

- Fast installation without disturbing your display.
- Snaps directly under shelving.
- Holds many shapes.
- This unique system fits .125" & .25" pegboard.
- Holds signs in a variety of directions.

Item No.	Ref. No.	Dimensions	Finish	Pack
2157935946	R58-MPT-10	10" L x .149" Dia.	Galv.	100
2150576156	R58-MPT-12	12" L x .149" Dia.	Galv.	100

Fastback® Adjustable Straight Sign Hanger

- Ideal for marking different product categories or promotions in an aisle.
- Sign hanger extends 16" D x 1"H.
- Holds signage in the flag position and can be used as aisle markers.
- Custom order to any dimension or color. Minimum quantities apply.
- Use for header sign or aisle markers.

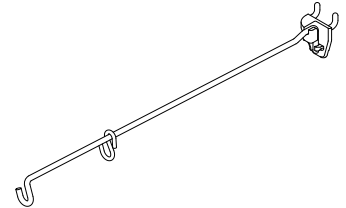
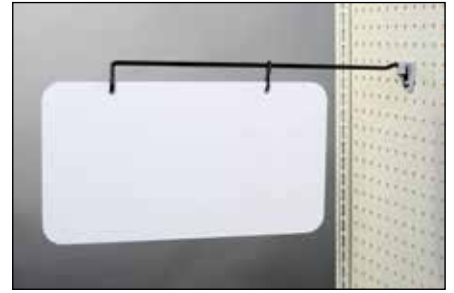

Item No.	Ref. No.	Dimensions	Finish	Pack
2151914191	RFAV-SA16-K	16" L	Black	10

Fastback® Adjustable Arc Sign Hanger

- Ideal for marking different product categories or promotions in an aisle.
- Sign hanger extends 16" D x 8" H.
- Holds signage in the flag position and can be used as aisle markers.
- Moveable S-Hook allows adjustability for signs with different hanging hole spreads.
- Custom order to any dimension or color. Minimum quantities apply.
- Use for header sign or aisle markers.

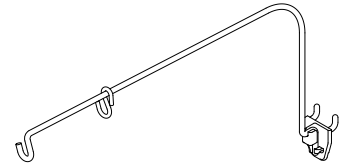

Item No.	Ref. No.	Dimensions	Finish	Pack
2151440299	RFAV-T16-K	16" L x 8" H	Black	10

Fastback® Vertical Mount Sign Hanger

- Displays product categories above standard gondola.
- Allows customers to easily navigate aisles with header signs.
- Holds signs up to 16" H.
- Single hook design.
- Holds signage in flush position on top of the gondola.
- Hook is 16" H.
- Powder-coated black.
- Holds custom high density foam core and Sintra board signs.
- Special hook is designed to not tip backwards.

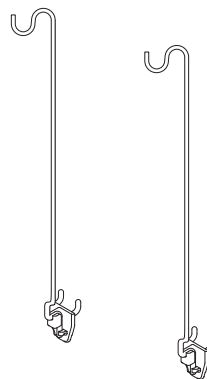

Item No.	Ref. No.	Dimensions	Finish	Pack
2157262070	RFAV-VP16-K	1" D x 16" H	Black	10

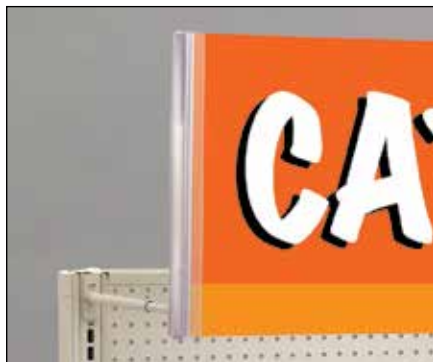

Bracket Sign System

Create your own sign system using siffron's interchangeable sign holders and brackets. Sign Holders are available in flag and flush styles, in multiple sizes and colors. Select SuperGrip® styles for the most secure hold on signage. Our wide variety of brackets are compatible with gondola shelf channels, gondola and warehouse uprights, pegboard, slatwall, square-edge fixtures, and flat surfaces.

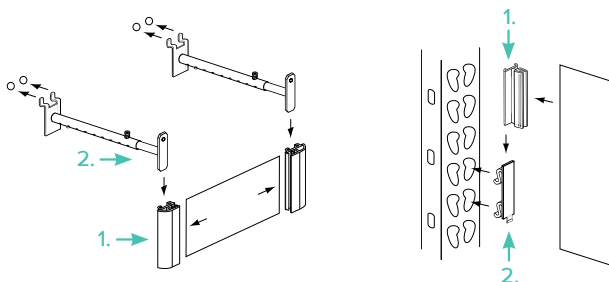

An easy-to-use sign system

1. Choose any Sign Holder/Adapter (pages 212-214)
2. Select any Bracket (page 222)
3. Insert the Sign Holder onto the Bracket

SIGN HOLDERS



SuperGrip® Header Sign Holder

- Choose from a variety of compatible brackets (page 220)
- SuperGrip® technology provides superior holding power
- End connectors are available with side sign holder for two-way signage
- End connectors are reversible; use two ends per sign
- Use center connectors for in-line signs
- Accepts rigid material .080" to .25" thick
- Available in multiple sizes; additional sizes can be Made To Order
- Patented when used with Bracket Sign System
- Natural polypropylene mount / clear PVC



1510635701



1516358001

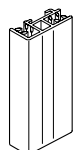

1510635741

Item No.	Ref. No.	Style	Dimensions	Pack
1510635701	-	End	4" L	1
1510635702	-	End	8" L	1
1510635703	-	End	12" L	1
1510635704	-	End	16" L	1
1510635741	-	End w/ Side SH	4" L	1
1510635742	-	End w/ Side SH	8" L	1
1510635744	-	End w/ Side SH	16" L	1
1516358001	-	Center	4" L	1
1516358002	-	Center	8" L	1
1516358003	-	Center	12" L	1
1516358004	-	Center	16" L	1

Additional lengths and colors can be made to order (minimum quantities apply.)

Flush Mount Adapter for Bracket System

- Use to mount displays to Bracket Sign System brackets (see page 210)
- Adhesive allows for easy display mounting
- 1.875" W x 3" H mounting area
- Clear PVC

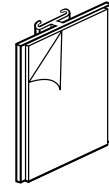
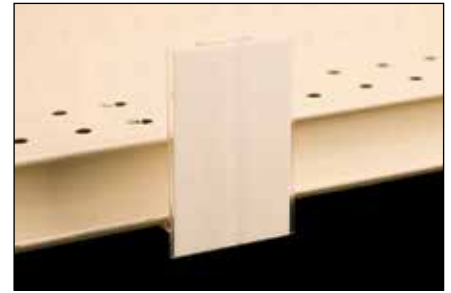

Item No.	Ref. No.	Dimensions	Finish	Pack
1503322301	-	1.875" W x 3" H	Clear	1

SuperGrip® Sign Holder

- Use with any of the brackets (page 220) to create a sign holder
- SuperGrip® technology provides superior holding power
- Offset style prevents shelving from interfering with signage
- Available with or without hinge; hinge allows signs to flex when bumped
- Available in two capacities to accept signage up to .100", or .100"-.250" thick
- 3" L or 4" L
- Clear PVC

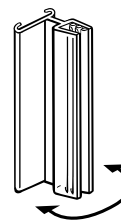

1516419501

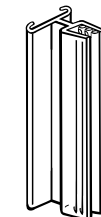

1514844301

Item No.	Ref. No.	Dimensions	Capacity	Pack
With Hinge				
1816579501	-	3" L	.100"	1
1816580001	-	3" L	.100"-.250"	1
1816579507	-	4" L	.100"	1
1816580007	-	4" L	.100"-.250"	1
Without Hinge				
1514844301	-	3" L	.100"	1
1516034301	-	3" L	.100"-.250"	1
Offset With Hinge				
1516419501	-	3" L	.100"	1
1516420001	-	3" L	.100"-.250"	1

Additional lengths and colors can be made to order (minimum quantities apply.)

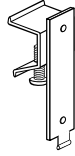

Channel Mount Bracket

- Fits most 1.25" shelf channels; comes with Phillips head machine screw for secure fit
- 2.625" H x .75" W mounting area
- Compatible with Sign Holder/Adapters (pages 212-214)
- Slide display onto mounting plate (.0625" capacity)
- Beige ABS

Item No.	Ref. No.	Dimensions	Finish	Pack
0604652201	-	.75" W x 2.625" H	Beige	1

SIGN HOLDERS

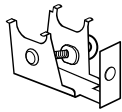

1503210001

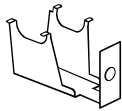

1503210002

Under-Shelf Spring-Mount Bracket

- Fits most standard perforated shelves; spring steel mount flexes so tabs clip securely into perforated shelf holes
- 1.5" H x .75" W mounting area
- Compatible with Sign Holder/Adapters (pages 212-214)
- Attach displays to mounting plate using Adhesive Pads or by tack welding; slide display onto mounting plate (.0625" capacity)
- Beige powder-coated metal

Item No.	Ref. No.	Style	Finish	Pack
1503210001	-	w/ screw	Beige	1
1503210002	-	w/o screw	Beige	1

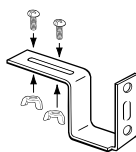

Under-Shelf Mount Bracket

- Fits most perforated shelves using included wing nuts and bolts
- 2" L x .75" W mounting area; features two .25" dia. mounting holes, 1.25" on center
- Compatible with Sign Holder/Adapters (pages 212-214)
- Attach displays to mounting plate using Adhesive Pads, fasteners or by tack welding; slide display onto mounting plate (.0625" capacity)
- Beige powder-coated metal

Item No.	Ref. No.	Finish	Pack
1817603602	-	Beige	1

Magnetic Under-Shelf Mount Bracket, L-Style

- Fits securely to most metal surfaces with heavy-duty magnet
- Compatible with Sign Holder/Adapters (pages 212-214)
- Beige or black ABS with magnetic base

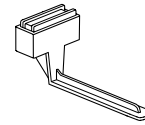

Item No.	Ref. No.	Finish	Pack
1816180600	-	Beige	1
1816180610	-	Black	1

Magnetic Under-Shelf Mount Bracket with Swivel

- Fits securely to most metal surfaces with heavy-duty magnet
- Bracket is hinged to allow signs to flex when bumped
- Compatible with Sign Holders/Adapters (pages 212-214); integrated screw can be adjusted to improve fit of Sign Holders/Adapters
- Beige or black ABS with magnetic base

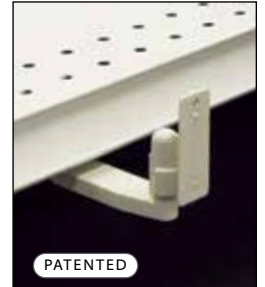
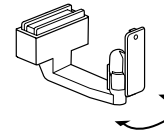

Item No.	Ref. No.	Finish	Pack
1816255300	-	Beige	1
1816255304	-	Black	1

Metal Shelf-Top Bracket

- Fits most standard perforated shelves
- .875" H x .75" W mounting area; features one .1875" diameter mounting hole
- Compatible with Sign Holders/Adapters (pages 212-214)
- Can also slide displays onto mounting plate (.0625" capacity)
- Beige powder-coated metal

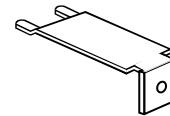

Item No.	Ref. No.	Finish	Pack
7909128401	-	Beige	1

Shelf-Top Bracket

- Fits most perforated shelves, and is can be repositioned
- 3" H x .75" W mounting area
- Compatible with any of the Sign Holders/Adapters (pages 212-214)
- Can also slide displays onto mounting plate (.0625" capacity)

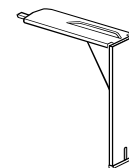

Item No.	Ref. No.	Finish	Pack
1509587601	-	Beige glass-filled nylon	1

Metal C-Clamp Bracket

- Fits shelves or other fixtures up to 1.5" thick
- 1.75" H x .75" W mounting area; features two .1875" diameter mounting holes
- Sign style is notched to be compatible with any of the Sign Holders/Adapters (pages 212-214)
- Attach displays using Adhesive Pads, fasteners or by tack welding
- Can also slide displays onto mounting plate (.0625" capacity)
- Zinc-plated metal

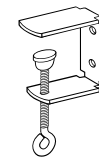

1812524300

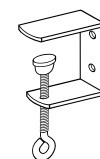

8401277701



Item No.	Ref. No.	Dimensions	Pack
1812524300	-	Sign - w/ Notch	1
8401277701	-	Display - w/o Notch	1

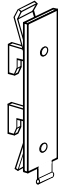

Gondola Upright Bracket

- Fits most standard gondola upright slots .375" W x .75" H, 1" on center
- 2.5625" H x .75" W mounting area
- Compatible with any of the Sign Holders/Adapters (pages 212-214)
- Attach displays using Adhesive Pads
- Can also slide displays onto mounting plate (.0625" capacity)
- White ABS

Item No.	Ref. No.	Finish	Pack
1515175701	-	White	1



Pegboard Bracket

- Fits most standard pegboard and can be repositioned
- 2.625" H x .75" W mounting area
- Compatible with any of the Sign Holders/Adapters (pages 212-214)
- Attach displays using Adhesive Pads
- Can also slide displays onto mounting plate (.0625" capacity)
- White ABS

Item No.	Ref. No.	Finish	Pack
2115893801	-	White	1

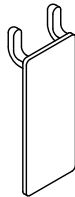

Pegboard / Slatwall Mount Plate for SuperGrip®

- Fits into standard .25" pegboard or slatwall.
- Ideal for placement of SuperGrip® with Adhesive, signs, and small displays.

Item No.	Ref. No.	Dimensions	Finish	Pack
1509600769	RFB-125-3	1.25" W x 3" H	White	10



Slatwall Bracket

- Fits most standard slatwall and can be repositioned
- 1.625" H x .75" W mounting area
- Compatible with any of the Sign Holders/Adapters (pages 212-214)
- Attach displays using Adhesive Pads
- Can also slide displays onto mounting plate (.0625" capacity)
- Natural polypropylene

Item No.	Ref. No.	Finish	Pack
2112873401	-	Natural	1

Warehouse Upright Bracket, Teardrop Hole

- Fits most standard warehouse uprights
- 2 3/4" H x 3/4" W mounting area
- Compatible with any of the Sign Holders/Adapters (pages 212-214)
- Attach displays using Adhesive Pads
- Can also slide displays onto mounting plate (1/16" capacity)
- White ABS



Item No.	Ref. No.	Finish	Pack
2112735402	-	White	1

Warehouse Upright Bracket, Square Hole

- Fits into most standard warehouse upright square holes and can be repositioned
- Compatible with any of the Sign Holders/Adapters (pages 212-214)
- 2 3/4" H x 3/4" W mounting area
- Attach displays using Adhesive Pads
- Can also slide displays onto mounting plate (1/16" capacity)
- White ABS



Item No.	Ref. No.	Finish	Pack
1506584201	-	White	1



Swivo•Clips™

With siffron's family of Swivo•Clips™, your options are limited only by your imagination. Clips, suction cups, magnets, and flat, stable platforms let you display signs just about anywhere. And the freedom of movement allowed by Swivo•Clips™ universal knuckles means you can display signage from any angle and point-of-view. High-quality clear construction keeps attention on signage, and options are available to meet your needs – clear or white knuckles to work with your décor, metal springs for maximum durability or rust-resistant plastic springs for use in wet environments. And all-black sign holders are ideal for fresh areas. Swivo•Clips™ are your creative solution for creating eye-catching signage everywhere!

SIGN HOLDERS



Swivo•Clip™ with Adhesive Adapter 0907

- Position it horizontally, vertically or anywhere in between
- Adheres to signs or displays with clear permanent adhesive
- Universal knuckle tilts in any direction
- Displays material up to .3125" thick
- 2.25" overall length
- Clear plastic with white or clear knuckle

Item No.	Ref. No.	Spring	Style	Pack
2804962601	-	Metal	White Base & Knuckle	1
2804962609	RSC-0009	Plastic	Clear Base & Knuckle	1

Swivo•Clip™ Double Sign Holder 0904

- Two crystal-clear clips connected by a universal knuckle
- Clear knuckle style provides a clean look and keeps attention on signage and product
- Both clips hold material up to .375" thick
- 3.5" overall length
- Clear plastic with white or clear knuckle / metal spring

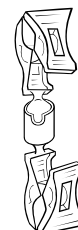

Item No.	Ref. No.	Spring	Style	Pack
2809161001	RSC-0001	Metal	White Knuckle	1
2809161007	-	Metal	Clear Knuckle	1

Swivo•Clip™ Wire Sign Holder 1201

- Wire extender displays signs well above merchandise
- Universal knuckles tilt and rotate at bottom and top
- Clip fits materials up to .375" thick
- Displays material from .008" to .020" thick
- 4" wire extender
- 7.5" overall length
- Clear plastic with white knuckle / metal spring



Item No.	Ref. No.	Spring	Style	Pack
2803159501	RSC-0013	Metal	White Knuckle	1

Swivo•Clip™ Sign Holder 0801

- Universal knuckle allows the crystal-clear sign holder to tilt in any direction
- Clear knuckle style provides a clean look and keeps attention on signage and product
- Clip fits signs or fixtures up to .375" thick
- Displays material from .008" to .020" thick
- 2.75" overall length
- Clear plastic with white or clear knuckle / metal spring



Item No.	Ref. No.	Spring	Style	Pack
2809010601	RSC-0002	Metal	White Knuckle	1
2809010612	-	Metal	Clear Knuckle	1

SIGN HOLDERS



Swivo-Clamp™ Sign Clip 0905

- Display signs on a variety of fixtures with versatile double-clip style
- Universal knuckle allows signs to tilt to the ideal viewing angle
- Clear knuckle style provides a clean look and keeps attention on signage and product
- Large clip grips fixtures up to .375" thick; small clip grips signs up to .125" thick
- Large clip is lined with anti-slip coating
- 4.5" overall length
- Clear plastic with white or clear knuckle / metal spring

Item No.	Ref. No.	Spring	Style	Pack
2809161018	-	Metal	White Knuckle	1
2809161019	-	Metal	Clear Knuckle	1



Swivo-Clamp™ Sign Holder 4008

- Larger clip allows you to install signs on thicker display surfaces
- Universal knuckle allows the sign holder to tilt in any direction
- Clear knuckle style provides a clean look and keeps attention on signage and product
- Clip lined with anti-slip coating
- Available with metal spring, or plastic spring for misted environments
- Clip grips materials up to 1.125" thick
- Displays material from .008" to .020" thick
- 4" overall length
- Clear plastic with white or clear knuckle

Item No.	Ref. No.	Spring	Style	Pack
2800154701	RSC-0005	Metal	White Knuckle	1
2800154716	-	Metal	Clear Knuckle	1
2809254001	-	Plastic	White Knuckle	1
2809254002	-	Plastic	Clear Knuckle	1

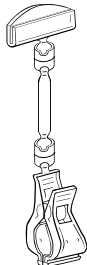

Swivo-Clamp™ Extended Sign Holder 1602

- Display signs above a variety of fixtures
- Universal knuckles allow you to tilt and rotate the bottom and the top
- Clip lined with anti-slip coating
- Clear knuckle style provides a clean look and keeps attention on signage and product
- Available with metal spring, or plastic spring for misted environments
- Clip grips materials up to .125" thick
- Displays material from .008" to .020" thick
- 2" extender; 6" overall length
- Clear or black plastic with clear sign holder

Item No.	Ref. No.	Spring	Style	Pack
2806355301	-	Metal	White Knuckle	1
2806355304	RSC-0006	Metal	Clear Knuckle	1
2807778501	-	Clear Plastic	White Knuckle	1
2807778502	-	Clear Plastic	Clear Knuckle	1
9920715452	-	Black Plastic	Black Knuckle	1

SIGN HOLDERS

Swivo•Clamp™ Wide Sign Holder 4022

- Perfect when you need a stronger grip on your signs
- Universal knuckle tilts materials in any direction
- Extra-firm grip sign holder, 3" W
- Clip lined with anti-slip coating
- Clear knuckle style provides a clean look
- Available with metal spring, or plastic spring for misted environments
- Fits on fixtures up to 1.125" thick
- Displays material up to .25" thick
- 4" overall length
- Clear or black plastic



Item No.	Ref. No.	Spring	Style	Pack
2807818801	RSC-0007	Metal	White Knuckle	1
2807818806	-	Metal	Clear Knuckle	1
2805693105	-	Clear Plastic	White Knuckle	1
2805693108	-	Clear Plastic	Clear Knuckle	1
9920715454	-	Black Plastic	Black Knuckle	1

Swivo•Clamp™ Extended Wide Sign Holder 1605

- An extra-firm grip sign holder with extender
- Universal knuckles tilt and rotate at bottom and top
- Clip lined with anti-slip coating
- Clear knuckle style provides a clean look and keeps attention on signage and product
- Available with metal spring, or plastic spring for misted environments
- Fits on fixtures up to 1.125" thick
- Displays material up to .25" thick
- 1.75" extender; 6.25" overall length
- Clear or black plastic



Item No.	Ref. No.	Spring	Style	Pack
2804096101	RSC-0008	Metal	White Knuckle	1
2804096111	-	Metal	Clear Knuckle	1
2803228301	-	Clear Plastic	White Knuckle	1
2803228302	-	Clear Plastic	Clear Knuckle	1
9920715453	-	Black Plastic	Black Knuckle	1



Swivo-Clamp™ Sign Protector 1607

- Covers and protects signs while on display
- Universal knuckle holds signs at almost any angle
- Clear knuckle style provides a clean look and keeps attention on signage and product
- Available with metal spring, or plastic spring for misted environments
- Clip is lined with anti-slip coating
- Clip grips materials up to 1.125" thick
- Displays material up to .03125" thick
- 9920710499 is the sleeve only
- Clear plastic sleeve / clear plastic clip



Item No.	Ref. No.	Dimensions	Spring	Style	Pack
9920710499	-	2.5" H x 3.75" L	n/a	Sleeve	1
9920716316	-	2.5" H x 3.75" L	Metal	White Knuckle	1
9920716315	-	2.5" H x 3.75" L	Clear Plastic	Clear Knuckle	1
2804823501	-	3.5" H x 5.5" L	Metal	White Knuckle	1
2804823502	-	5" H x 7" L	Metal	White Knuckle	1
2804823509	-	5" H x 7" L	Clear Plastic	Clear Knuckle	1

SIGN HOLDERS

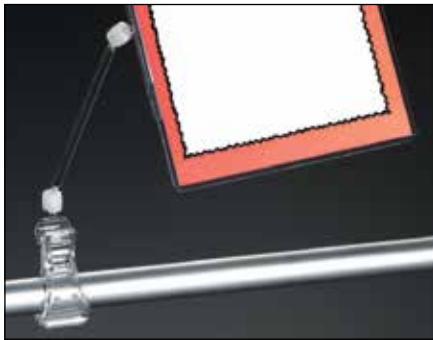

Swivo-Clamp™ Extended Sign Protector 1609

- Protects and elevates signage – universal knuckles allow you to tilt and rotate at bottom and top
- Clip lined with anti-slip coating
- 3.75" clear extender
- Clip grips materials up to 1.125" thick
- Displays material up to .03125" thick
- Clear plastic with white knuckle / metal spring

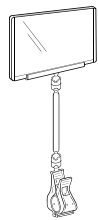

Item No.	Ref. No.	Dimensions	Style	Pack
2800342702	-	5" H x 7" L	White Knuckle	1



Swivo-Clamp™ Sign Holder with Two-Way Swivel

- Perfect for displaying signs on stainless steel or melamine pans, or fixtures throughout the store
- Two-Way Swivel tilts sign to the front or back for the ideal viewing angle
- Extra-firm grip sign holder is 3" W
- Plastic spring for misted environments
- Fits on fixtures up to 1" thick
- Displays materials up to .25" thick
- Clear plastic
- Packaged 25/bag; sold in full bags only

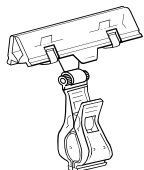

Item No.	Ref. No.	Dimensions	Finish	Pack
2805651002	-	4" L	Clear	25

Swivo•Clip™ Round Base Extended Wide Sign Holder 2804

- Counter top sign holder with attractive round base
- Universal knuckle at top tilts materials in any direction
- Extra-firm grip sign holder
- Holds material up to .25" thick
- 4.5" diameter base
- White base and stem, clear plastic sign holder

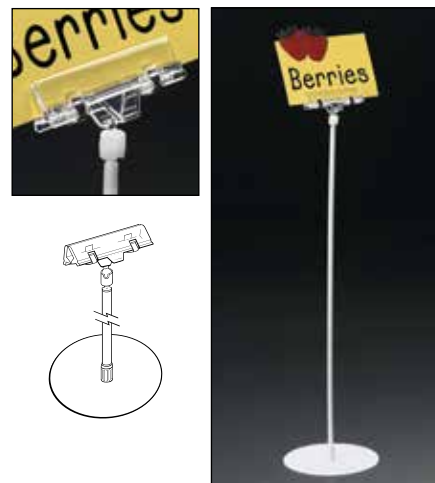

Item No.	Ref. No.	Dimensions	Style	Pack
2805218001	-	18" L	White Knuckle	1

Swivo•Clip™ Suction Cup Sign Holder 1803

- Attaches to glass surfaces
- Universal knuckles tilt and rotate from bottom and top
- Displays material up to .375" thick
- 4" L wire extender; 6.5" overall length
- 1.5" O.D. suction cup
- Clear plastic

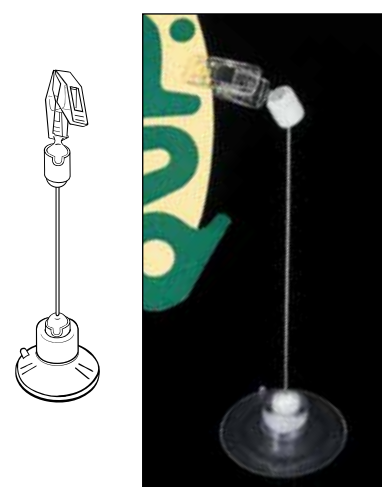

SIGN HOLDERS

Item No.	Ref. No.	Dimensions	Style	Pack
2806112901	RSC-0015	6.5" L	White Knuckle	1

Swivo•Clip™ Magnetic Sign Holder 2102

- Attaches firmly to most metal surfaces
- Universal knuckles tilt and rotate from bottom and top
- Magnetic base for use on most metal surfaces, 1.25" diameter
- Displays material .375" thick
- 4" L wire extender; 7" overall length
- White base / clear plastic clip with white knuckles
- **WARNING:** Do not use near sensitive electronic equipment



Item No.	Ref. No.	Dimensions	Style	Pack
2806944501	RSC-0014	7" L	White Knuckle	1



Swivo-Clip™ Flexible Double

- Two clear spring-clips connected with ball and socket Swivo™ joints to a flexible extender
- Extender available in white and black.
- Custom colors available, call for details.
- Each individual spring clip is .75" W x 1.5" H.
- High quality polycarbonate with spring steel construction.
- Available in Black or White.

Item No.	Ref. No.	Dimensions	Finish	Pack
2804868644	RSC-0004K	12.2" H x .75" W	Black	25

SIGN HOLDERS

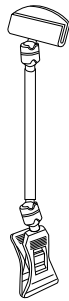

Swivo-Clip™ Extended Sign Holder

- Allows you to add unique angles and dimensions to your promotions.
- Single clear spring-clip and clear sign holder connected with ball and socket Swivo™ joints to a clear 4" extender.
- Designed to hold up to .020" thick material.
- Sign holder dimensions are 1" W x .625" H.
- Individual spring clip is .75" W x 1.5" H.
- High quality polycarbonate with spring steel construction.

Item No.	Ref. No.	Dimensions	Finish	Pack
2802299993	RSC-0003	7" H x 1" W	Clear	25

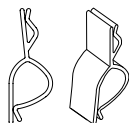

Swivo-Clip™ Sign Holder

- Ideal for clipping onto shoes or other items up to .375" thick.
- High quality PVC with tension grip construction.
- Individual sign holder is .15" W x 4" H.
- Holds signs up to .080" thick.

Item No.	Ref. No.	Dimensions	Finish	Pack
2805856583	R-SHSC	1.5" x 4"	Clear	25

Perfect View™ Sign System for Wire

- Ratcheting design allows sign to be displayed in ideal position for the perfect view
- Two-piece sign system: Adapter and Sign Holder
- Available in kits or individual components
- Adapter fits .188" to .375" diameter wire; 2" L
- Clear butyrate
- Components ship unassembled

Holders

- Small (3501655701): Holds 1.25" H x 3" L signs up to .040" thick
- Large (3502445003): Holds 3.5" H x 5.5" L signs up to .030" thick

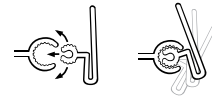

Insert the sign holder into the adapter and rotate it to the perfect viewing position.

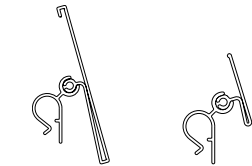

3501000102

3501000101

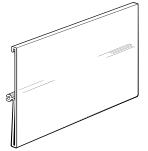
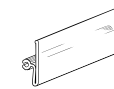
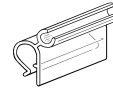

3557919601

3501655701

3502445003

Item No.	Ref. No.	Style	Finish	Pack
3501000101	-	Kit w/ Small Holder	Clear	1
3501000102	-	Kit w/ Large Holder	Clear	1
3557919601	-	Adapter	Clear	1
3501655701	-	Small Holder	Clear	1
3502445003	-	Large Holder	Clear	1

Perfect View™ Sign System for Shelf Channel

- Ratcheting design allows sign to be displayed in ideal position for the perfect view
- Two-piece sign system: Adapter and Sign Holder
- Available in kits or individual components
- Adapter fits most 1.25" H shelf channels; 2" L
- Clear butyrate
- Components ship unassembled

Holders

- Small (3501655701): Holds 1.25" H x 3" L signs up to .040" thick
- Large (3502445003): Holds 3.5" H x 5.5" L signs up to .030" thick

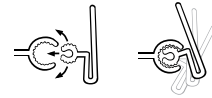

Insert the sign holder into the adapter and rotate it to the perfect viewing position.

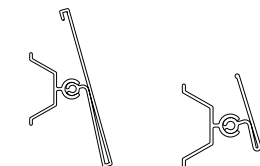

3501000104

3501000103

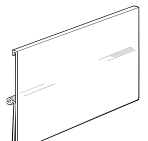
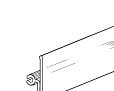
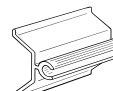

3558043501

3501655701

3502445003

Item No.	Ref. No.	Style	Finish	Pack
3501000103	-	Kit w/ Small Holder	Clear	1
3501000104	-	Kit w/ Large Holder	Clear	1
3558043501	-	Adapter	Clear	1
3501655701	-	Small Holder	Clear	1
3502445003	-	Large Holder	Clear	1

SIGN HOLDERS

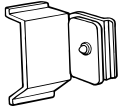

0227963601

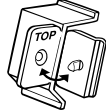

0227963608

Fold•N•Hold® Shelf Channel Flag Sign Holder FO-104

- Punctures and holds signs securely in the flag position, even in low temperatures
- Holds most paper signs up to .012" thick
- Fits most standard 1.25" shelf channels
- Standard style holds signs parallel to angled shelf channel; angled style holds signs parallel to the floor
- Natural polypropylene
- Packaged: 50/bag

Item No.	Ref. No.	Style	Dimensions	Pack
0227963601	-	Standard	.75" W x 1.25" H	50
0227963608	-	Angled	.75" W x 1.25" H	50

Additional colors can be made to order (minimum quantities apply.)

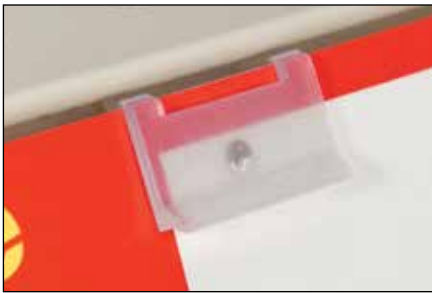

0222247301

Fold•N•Hold® Shelf Channel Flush Sign Holder FO-102

- Punctures and holds signs securely in the flush position, even in low temperatures
- Holds most paper signs up to .012" thick
- Also available as kit with vinyl pouch; signs slide into pouch for protection
- Fits most standard 1.25" shelf channels
- Natural polypropylene sign holder / clear vinyl pouch

Item No.	Ref. No.	Style	Dimensions	Pack
0222247301	RDC-020	Sign Holder	1.125" W x 1.25" H	50

Additional colors can be made to order (minimum quantities apply.)

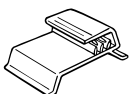
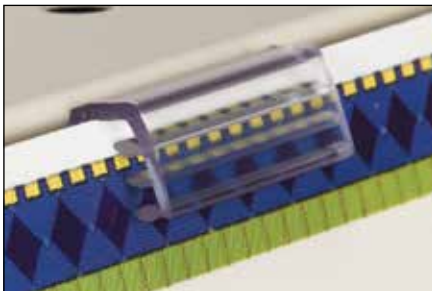

0118113101
(102)

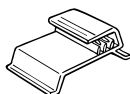

0111705702
(102F)



0118163302
(302)

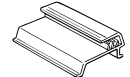

0112460502
(402F)

SuperGrip® Shelf Channel Sign Holder

- SuperGrip® brand technology provides superior holding power
- Fits securely into most standard 1.25" shelf channels
- Holds sign material up to .080" thick
- Clear PVC
- 102 Model: Standard mount fits most 1.25" shelf channels
- 102F Model: Soft flexible feet for easy installation
- 302 model: Longer leg for a secure fit
- 402F Model: Soft flexible bead for a secure fit

Item No.	Ref. No.	Model	Dimensions	Pack
0118113101	-	102 Model	.5" L	1
0118113102	-	102 Model	1" L	1
0111705702	-	102F Model	1" L	1
0118163302	-	302 Model	1" L	1
0112460501	-	402F Model	.5" L	1
0112460502	-	402F Model	1" L	1

Additional lengths and colors can be made to order (minimum quantities apply.)

SuperGrip® UPC Tag/Sign Holder 107

- Extra SuperGrip® fin adds holding power
- 0117633601: fits most 1.25" shelf channels
- 0117633604: fits most 1.5" shelf channels
- Holds materials up to .080" thick
- Clear PVC

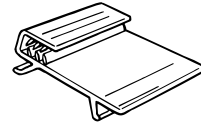
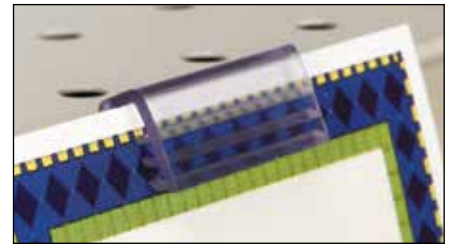

Item No.	Ref. No.	Dimensions	Finish	Pack
0117633601	RFG2-011-125	1.25" L x 1.25" H	Clear	1
0117633604	-	.75" L x 1.5" H	Clear	1

Additional lengths and colors can be made to order (minimum quantities apply.)

SuperGrip® UPC Tag/Sign Holder with Hinge 107F

- Flexible hinge feature allows signs to flip up, revealing UPC information underneath
- UPC labels adhere to flat surface
- SuperGrip® brand technology provides superior holding power
- Fits most 1.25" shelf channels
- Holds material up to .080" thick
- Clear PVC

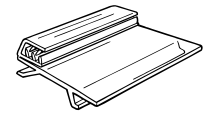
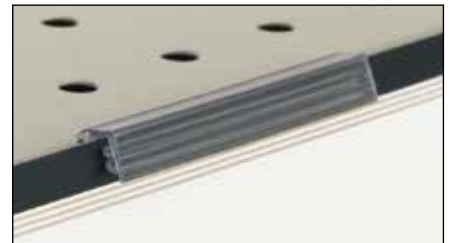

Item No.	Ref. No.	Dimensions	Finish	Pack
0117633603	-	2.5" L x 1.75" H	Clear	1

Additional lengths and colors can be made to order (minimum quantities apply.)

SuperGrip® Flag Sign Holder 404

- SuperGrip® brand technology securely holds signs in the flag position
- Fits most standard 1.25" shelf channels
- Holds material up to .080" thick
- Standard style holds signs parallel to angled shelf channel; angled style holds signs parallel to the floor
- Clear PVC



0212045101

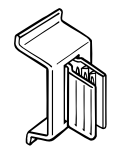

0212045170

Item No.	Ref. No.	Style	Dimensions	Pack
0212045101	R17-715	Standard	.75" W	1
0212045170	-	Angled	.75" W	1

Additional colors can be made to order (minimum quantities apply.)

SuperGrip® Twist-In Sign Holder 104

- Just insert and twist for secure locking action in shelf channels
- Fits most standard 1.25" shelf channels
- Holds material up to .080" thick
- 1.25" length
- Clear PVC

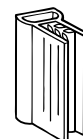
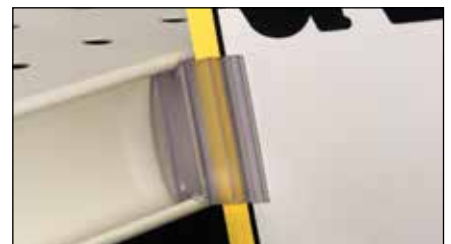

Item No.	Ref. No.	Dimensions	Finish	Pack
0212006001	-	1.25" L	Clear	1

Additional lengths and colors can be made to order (minimum quantities apply.)

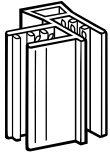

SuperGrip® Two-Way Twist-In Sign Holder

- Displays signs in both flag and flush position
- Twists into most 1.25" H shelf channels
- Holds signs up to .080" thick
- Clear PVC

Item No.	Ref. No.	Dimensions	Finish	Pack
0218947801	-	1.25" L	Clear	1

Additional colors can be made to order (minimum quantities apply.)

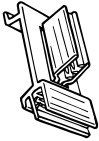

SuperGrip® Dual Action Flag Sign Holder 204

- Double your promotional possibilities by holding two signs at once
- SuperGrip® brand technology provides secure hold for signs
- Fits most 1.25" shelf channels
- Holds materials up to .080" thick in both flush and flag position
- Clear PVC

Item No.	Ref. No.	Dimensions	Finish	Pack
0210950701	-	.75" W x 1.625" H	Clear	1

Additional colors can be made to order (minimum quantities apply.)



Shelf Channel Sign Holder

- A more economical choice with friction fit rather than SuperGrip® holding action
- Flexible to fit securely into most standard and oversized 1.25" shelf channels
- Holds material up to .018" thick
- Clear PVC

Item No.	Ref. No.	Dimensions	Finish	Pack
0601767800	-	1.25" L x 1.25" H	Clear	1

Additional lengths and colors can be made to order (minimum quantities apply.)

Double-Duty™ Metal Shelf Channel Sign Holder 2495

- Provides maximum holding power for coated or plastic signs
- Holds signs in flag or flush position
- Fits most 1.25" shelf channels
- Holds material up to .050" flag position, .030" flush position
- Stainless steel

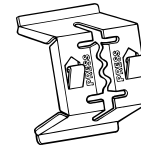

Item No.	Ref. No.	Dimensions	Finish	Pack
0507973200	-	1" W	Silver	1

Double-Duty™ Econo Shelf Channel Sign Holder 2440

- Plastic clips securely hold all types of signs in flag or flush position
- Fits most 1.25" shelf channels
- Holds material up to .050" flag position, .040" flush position
- Natural or white polypropylene
- Packaged: 50/bag

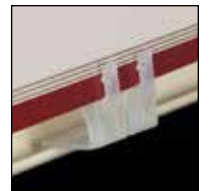
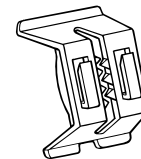

Item No.	Ref. No.	Dimensions	Finish	Pack
0507475901	-	1" W	Natural	50
0507475902	-	1" W	White	50

Additional colors can be made to order (minimum quantities apply.)

Double-Duty™ Shelf Channel Sign Holder 2435

- Plastic clips securely hold all types of signs in flag or flush position
- Fits most 1.25" shelf channels
- Holds material up to .050" flag position, .040" flush position
- Acetal material is perfect for freezer environments
- Packaged: 50/bag

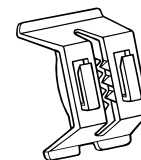

Item No.	Ref. No.	Dimensions	Finish	Pack
0507531601	R16-4W-100BG	1" W	Natural Acetal	1
0507531602	-	1" W	White ABS	1

Additional colors can be made to order (minimum quantities apply.)

SIGN HOLDERS

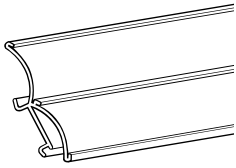

Double Curved C-Channel for Shelf Channel

- Two-channel design enables simultaneous delivery of pricing, plus category or product messages
- Fits securely into 1.25" H Lozier and Madix shelf channels
- Holds 1.25" H signage in both top and bottom c-channels
- Channel Insert Strips are available in multiple colors
- Clear PVC

Item No.	Ref. No.	Dimensions	Finish	Pack
4306300302	-	47.875" L	Clear	1

Additional lengths and colors can be made to order (minimum quantities apply.)

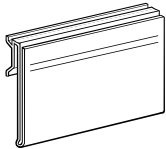

Flip-Up Sign Holder for Shelf Channel

- Integrated hinge flips up to allow access to product below
- Channel mount fits most standard 1.25" H shelf channels
- Holds and protects signs 3.52" H
- Available in two lengths
- Clear PVC

Item No.	Ref. No.	Dimensions	Finish	Pack
4203891701	-	3.5" H x 5.5" L	Clear	1
4203891702	-	3.5" H x 47.625" L	Clear	1

Additional lengths can be made to order (minimum quantities apply.)

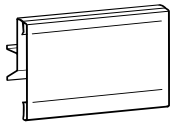

Clear Hinged Sign Holder

- Clear Hinged Sign Holder
- Hinged sign holder flips out of the way for stocking and safety
- Covered-face protects signs
- Fits standard 1.25" channels
- Holds signs 3.5" H x 5.5" W
- Clear plastic

Item No.	Ref. No.	Dimensions	Finish	Pack
9920714418	-	3.5" H x 5.5" W	Clear	1

Additional sizes can be made to order (minimum quantities apply.)

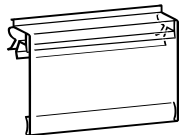

Multi-Mount Covered-Face Sign Holder

- Single signage solution for multiple fixture styles throughout the store
- Fits most 1.25" H shelf channels, wire fixtures up to .375" diameter, and panel thicknesses of .080" to .250"
- Holds 3.5" H x 5.5" L signs
- Clear butyrate

Item No.	Ref. No.	Dimensions	Finish	Pack
0400542202	-	3.5" H x 5.5" W	Clear	1

Additional lengths can be made to order (minimum quantities apply.)

Clear Covered-Face Sign Holder Center Shelf Mount CS2020

- Protects and centers signs on shelf channels
- Fits most standard 1.25" shelf channels
- Holds 3.5" H x 5.5" L signs
- Clear butyrate



Item No.	Ref. No.	Dimensions	Finish	Pack
0402153802	-	3.5" H x 5.5" L	Clear	1

Additional lengths can be made to order (minimum quantities apply.)

Econo Covered-Face Sign Holder Center Shelf Mount CS2020

- Economically protects and centers signs on shelf channels
- Fits most standard 1.25" shelf channels
- Holds 3.5" H x 5.5" L signs
- Clear PVC

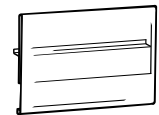

Item No.	Ref. No.	Dimensions	Finish	Pack
0402153809	R16-35X55SH	3.5" H x 5.5" L	Clear	1

Additional lengths can be made to order (minimum quantities apply.)

Clear Covered-Face Sign Holder Below Shelf Mount BS2020

- Protects and mounts signs below shelf surface
- Fits most standard 1.25" shelf channels
- Holds 3.5" H x 5.5" L signs
- Clear PETG



Item No.	Ref. No.	Dimensions	Finish	Pack
0402118502	-	3.5" H x 5.5" L	Clear	1

Additional lengths can be made to order (minimum quantities apply.)

Top Mount Sign Holder

- Holds standard 3.5" x 5.5" signs.
- Fits in standard 1-.25" shelf channel, such as Lozier and Madix shelves.
- Hangs below shelf.
- Clear front allows your message to be seen easily.

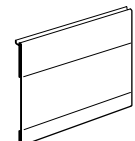

Item No.	Ref. No.	Dimensions	Finish	Pack
0404425386	R16-35X55SHT	3.5" H x 5.5" W	Clear	50

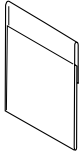

Hang Clear™ Full Channel

- Flexible PVC hangs below the surface of the shelf or suspended from wire in produce sections.
- Fits in Data Strip® Price Tag Channels and standard 1.25" shelf edge.
- Heat Folded .015" UV stable PVC.

Item No.	Ref. No.	Dimensions	Finish	Pack
0405827872	RSPC-FP-H5	3.5" H x 5.5" W	Clear	25
0408532953	RSPC-FP-H7	5.5" H x 7" W	Clear	25
0409403383	RSPC-FP-H11	7" H x 11" W	Clear	25

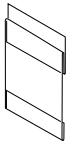

Hang Clear™ Mid-Channel

- Flexible PVC hangs in the center of the shelf.
- Heat Folded .015" UV stable PVC.

Item No.	Ref. No.	Dimensions	Finish	Pack
0406722608	RSPC-MP-H5	3.5" H x 5.5" W	Clear	25
0407935389	RSPC-MP-H7	5.5" H x 7" W	Clear	25
0401448666	RSPC-MP-H11	7" H x 11" W	Clear	25

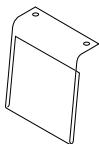

Hang Clear™ Pin Mount

- Works on any perforated shelf.
- Features two holes for push pins to hold it securely in place.
- Heat Folded .015" UV stable PVC.

Item No.	Ref. No.	Dimensions	Finish	Pack
1503933901	-	3.5" H x 48" L	Clear	1

Slim-Line Dual Mount Sign Protector

- Protects signs below shelf surface or center mounted in shelf channel
- Fits most standard 1.25" shelf channels and Data Strip® Label Holders
- Holds 3.5" H x 5.5" L signs
- Clear 15 mil PVC



Item No.	Ref. No.	Dimensions	Finish	Pack
0408314900	-	3.5" H x 5.5" L	Clear	1

Additional lengths can be made to order (minimum quantities apply.)

Tinted Covered-Face Sign Holder

- to organic produce or seasonal specials
- Economical, lightweight and flexible
- Protects signs behind a covered face and mounts below shelf surface
- Fits most standard 1.25" H shelf channels
- Green 15 mil PVC



Item No.	Ref. No.	Dimensions	Finish	Pack
0406050902	-	3.75" H x 8.5" L	Green	1

Additional attachment styles, lengths and colors can be made to order (minimum quantities apply.)

See-Thru Sign Protector ST3555

- A low-cost way to protect signs
- Holds up to 3.5" H x 5.5" L signs
- Shown with SuperGrip® Shelf Channel Sign Holder
- Clear 10 mil PVC

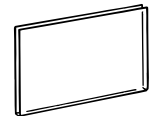

Item No.	Ref. No.	Dimensions	Finish	Pack
3107523601	-	3.5" H x 5.5" L	Clear	1

Additional lengths can be made to order (minimum quantities apply.)

Channel Mount with Adhesive

- Fits most standard 1.25" shelf channels
- Securely holds a variety of signs and displays
- 1.25" H x 2" L
- Permanent adhesive: 1" H x 2" L
- Clear PVC

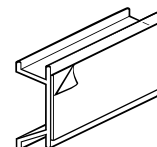

Item No.	Ref. No.	Dimensions	Finish	Pack
0601277701	RCM2-114	1.25" H x 2" L	Clear	1

Additional lengths and colors can be made to order (minimum quantities apply.)

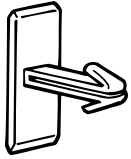

5307895101

Arrowhead® Fastener AF-101

- A cost-effective way to securely hold pads of coupons or single signs in the centered flush position
- Fits most standard 1.25" shelf channels
- 5307895102 has permanent adhesive for use on most flat surfaces
- Stem .5" L
- Natural polypropylene

Item No.	Ref. No.	Style	Finish	Pack
5307895101	-	w/o adh	Natural	1
5307895124	-	w/ adh	Natural	1

Additional colors can be made to order (minimum quantities apply.)

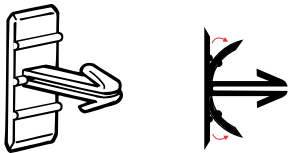

5307895104

Arrowhead® Fastener AF-101F

- Designed for even easier insertion into shelf channels
- Easy flex design
- Holds coupon pads or single signs
- Fits most standard 1.25" shelf channels
- Stem .5" L
- Natural polyethylene

Item No.	Ref. No.	Dimensions	Finish	Pack
5307895104	-	.5" L	Natural	1

Additional colors can be made to order (minimum quantities apply.)

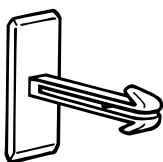

5307734801

Arrowhead® Fastener AF-102

- Securely pin coupon pads or single signs to shelf fronts
- Fits most standard 1.25" shelf channels
- 5307734802 has permanent adhesive for use on most flat surfaces
- Stem .875" L
- Natural polypropylene

Item No.	Ref. No.	Style	Finish	Pack
5307734801	R16-T-1	w/o adh	Natural	1
5307734802	R16-T-1A	w/ adh	Natural	1

Additional colors can be made to order (minimum quantities apply.)

Clear Wobbler Sign Holder

- Eye-catching versatile sign holder creates a "free-floating" effect
- Attaches to most perforated shelf tops and pegboard
- Includes versatile shelf mount, 15" stem, connector, and 17" curved wobbler with hook
- Wobbler features end hook to hold punctured signs
- Mount to any wall or flat surface with double-sided adhesive or .250" capacity fasteners
- Clear polycarbonate



Item No.	Ref. No.	Dimensions	Finish	Pack
0308726800	-	15" H Stem	Clear	1

Additional colors can be made to order (minimum quantities apply.)

Channel Wobbler Sign Holder

- Adds both motion and dimension to signage
- Fits most 1.25" shelf channels
- Protects 3.5" H x 5.5" L signs
- Clear 15 mil PVC

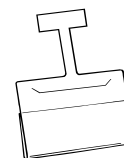

Item No.	Ref. No.	Dimensions	Finish	Pack
0304002701	-	3.5" H x 5.5" L	Clear	1

Channel Mount Spring Wobbler

- Add eye-catching motion to shelf channels
- Fits most 1.25" shelf channels
- Permanent adhesive holds signs and promotional items
- White polypropylene/polystyrene with
- 1" L metal spring

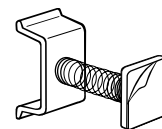

Item No.	Ref. No.	Dimensions	Finish	Pack
0302215002	-	1" L	White	1

Spring Wobbler

- Add eye-catching motion to nearly any display
- 1" L metal spring with adhesive mounting ends
- Adheres to any flat surface
- Holds signs and promotional items
- White polystyrene with metal spring

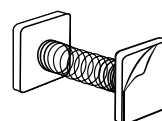

Item No.	Ref. No.	Dimensions	Finish	Pack
0302215000	-	1" L	White	1

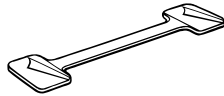
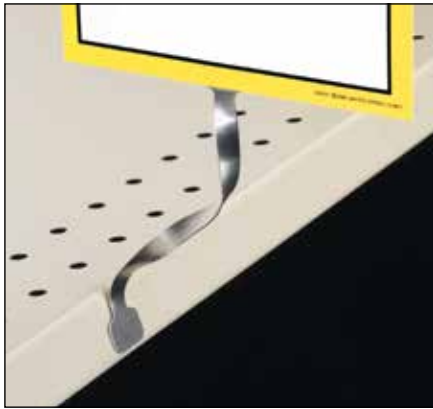

Twist-Pop® Sign Holder 7071

- Attach one end to a flat surface and give it a twist
- Available in 3.125" and 6" lengths
- Adhesive on both ends
- Soft aluminum

Item No.	Ref. No.	Dimensions	Finish	Pack
2407950101	-	3.125" L	Silver	1



Tapered

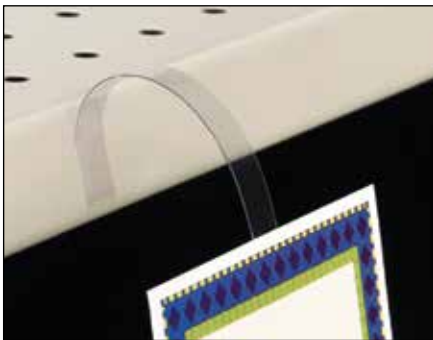

Straight

Wobbler

- Add both motion and dimension to displays
- Adhesive on both ends

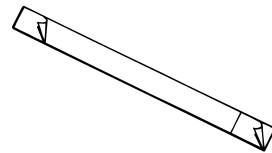
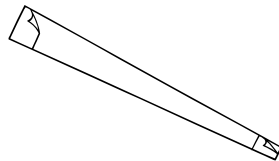

Tapered

- Tapered design adds both motion and dimension to displays
- Adhesive on both ends
- Clear 15 mil PVC
- Packaged: 100 per bag; sold in full bags only

Straight

- Made from thinner material to add more motion to any display
- For use on cut cases, products, easel cards, freezer doors and more
- Adhesive on both ends
- Clear 10 mil PVC
- Packaged: 1,000 per roll; sold in full rolls only

Item No.	Ref. No.	Dimensions	Finish	Pack
Tapered				
0302376301	RHT-8002-WB	6" L	Clear	100
0302376302	RHT-8003-WB	8" L	Clear	100
Straight				
0307927501	RHT-8001-WB	.375" W x 4" L	Clear	1,000/Roll
0307927503	-	.375" W x 6" L	Clear	1,000/Roll

Fold•N•Hold® Flag Sign Holder for Perforated Shelves FO-304

- Fold•N•Hold® technology punctures sign and displays it in the flag position
- Ideal for low-temperature applications
- Also available as kit with vinyl pouch; signs slide into pouch for protection
- Fits most standard perforated shelves
- Holds most paper signs up to .012" thick
- Natural polypropylene sign holder / clear vinyl pouch

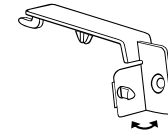

0226158201

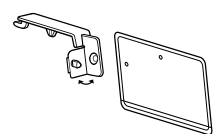

3220000100

Item No.	Ref. No.	Style	Dim.	Pack
0226158201	RDC-021	Sign Holder	.625" W	250

Additional colors can be made to order (minimum quantities apply.)

SuperGrip® Flag Sign Holder for Perforated Shelves 304

- Designed for most shelves with perforations
- SuperGrip® brand holder secures signs in flag position
- Attaches with E443 Dart Clip (included)
- Holds signs up to .080" thick
- Clear PVC

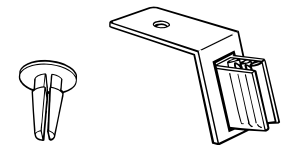

Item No.	Ref. No.	Dimensions	Finish	Pack
0217932002	-	.75" W	Clear	1

Fold•N•Hold® Flush Sign Holder for Perforated Shelves FO-119

- Fold•N•Hold® technology punctures sign and displays it in the flush position
- Ideal for low-temperature applications
- Also available as kit with vinyl pouch; signs slide into pouch for protection
- Fits most standard perforated shelves
- Holds most paper signs up to .012" thick
- Natural polypropylene sign holder / clear vinyl pouch



Item No.	Ref. No.	Style	Dimensions	Pack
0226279701	-	Sign Holder	.625" W	250

Additional colors can be made to order (minimum quantities apply.)

SuperGrip® Flush Sign Holder for Perforated Shelves 119

- Designed for most shelves with perforations
- SuperGrip® brand holder secures signs in flush position
- Attaches with E443 Dart Clip (included)
- Holds signs up to .080" thick
- Clear PVC

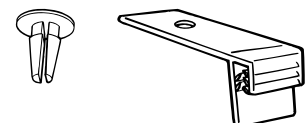

Item No.	Ref. No.	Dimensions	Finish	Pack
1812208702	-	.75" W x 1.5" L	Clear	1

Additional lengths and colors can be made to order (minimum quantities apply.)

SIGN HOLDERS

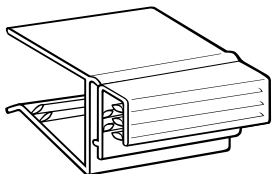

SuperGrip® Flush Sign Holder with Hinge 128

- SuperGrip® brand technology grips shelf and holds signs in the flush position
- Hinge allows sign to flip up
- Fits .5”-.625” thick metal and wood shelves
- Holds signs up to .080” thick
- Clear PVC

Item No.	Ref. No.	Dimensions	Finish	Pack
1813488701	-	1.5” L	Clear	1

Additional lengths and colors can be made to order (minimum quantities apply.)

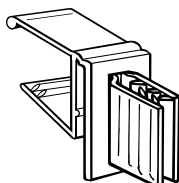

SuperGrip® Square Shelf Flag Sign Holder

- Features SuperGrip® brand holding power
- Flips up to move sign out of the way
- Attaches to .75” thick shelves
- Holds material up to .080” thick in flag position
- Clear PVC

Item No.	Ref. No.	Dimensions	Finish	Pack
1816988401	-	.75”	Clear	1

Additional colors can be made to order (minimum quantities apply.)

SuperGrip® Flush Sign Holder 128

- SuperGrip® brand technology grips shelf and holds signs in the flush position
- Two sizes fit metal and wood shelves .5"- .625" thick or .75"-1" thick
- Holds .080" thick materials
- 1.5" L
- Clear PVC

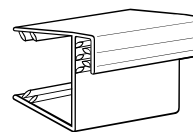

1818734801

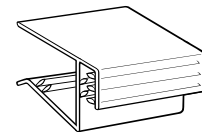

1818437801

Item No.	Ref. No.	Dimensions	Finish	Pack
1818437801	-	.5"- .625"	Clear	1
1818734801	-	.75"-1"	Clear	1

Additional lengths and colors can be made to order (minimum quantities apply.)

Covered-Face Sign Holder for Square Edge

- Covered-face sign holder easily clips onto tables
- Fits table and square edges .5" to .75" wide
- Holds and protects signs 3.5" H
- Available in 5.5" or 46.5" L
- Clear PVC



SIGN HOLDERS

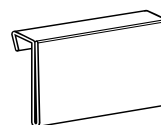

1507632202

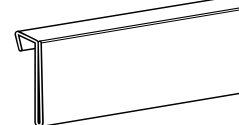

1507632201

Item No.	Ref. No.	Dimensions	Finish	Pack
1507632202	-	3.5" H x 5.5" L	Clear	1
1507632201	-	3.5" H x 46.5" L	Clear	1

Additional lengths can be made to order (minimum quantities apply.)

SuperGrip® Display Sign Holder

- SuperGrip® brand technology holds materials securely
- Ideal for holding signs flush on square edge fixtures
- One side holds material up to .080" thick, other side holds .750" thick material
- 1.5" L
- Clear PVC

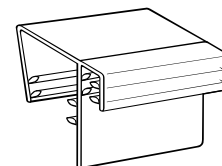

Item No.	Ref. No.	Dimensions	Finish	Pack
1810000000	-	.080"/.750"	Clear	1
8118842802	-	.080"/.170"	Clear	1

Additional lengths and colors can be made to order (minimum quantities apply.)

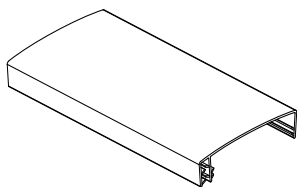
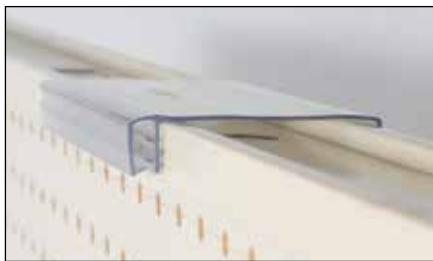

SuperGrip® for Gondola Flush Grip

- Designed to hold a sign to a metal surface.
- Holds up to .100" thick material.

Item No.	Ref. No.	Dimensions	Finish	Pack
1858076409	RFG2-HZSH-0760	6" W x .76" H x 3" D	Clear	10

SIGN HOLDERS

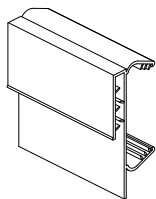

SuperGrip® for 2" Bar

- Clear PVC plastic with soft fingers for gripping signs.
- Ideal for creating flush mount graphics.
- RFG2-VTSH-2-310 - fits on 2" bar.
- Holds material up to .125" thick.
- Custom lengths available. Call for pricing.

Item No.	Ref. No.	Dimensions	Finish	Pack
1850921667	RFG2-VTSH-2-310	3" H x 3" W x 1.15" D	Clear	10

SuperGrip® Square Edge Sign Holder

- Features SuperGrip® gripping fins for maximum holding power
- Display signs vertically or horizontally
- Two capacities fit edges .625”-.75” thick or .875” to 1” thick
- Holds material up to .125” thick

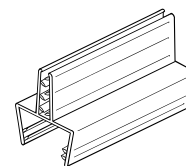
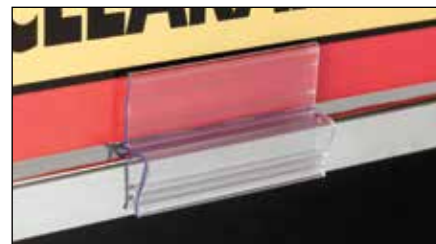

Item No.	Ref. No.	Dimensions	Fits	Pack
1811600901	-	3" L	.625"-.75"	1
1816456801	214814	3" L	.875" - 1"	1

Additional lengths and colors can be made to order (minimum quantities apply.)

SuperGrip® Square Edge Sign Holder with Hinge

- Add flag signage to square-edged fixtures, including metal and wood
- Hinge allows signs to flex when bumped
- SuperGrip® brand technology provides superior holding power
- Use two holders to support large blade signs
- Fits shelving and material .875”-1” thick
- Holds material up to .125” thick
- Clear PVC



Item No.	Ref. No.	Dimensions	Fits	Pack
1816286501	-	3" L	.875" - 1"	1

Additional lengths and colors can be made to order (minimum quantities apply.)

SuperGrip® Adhesive Sign Holder

- Ideal solution for attaching signs and literature holders to the shelf edge
- SuperGrip® holding power securely grips shelves
- Permanent foam adhesive tape holds a variety of materials
- Fits shelves .1875” to .3125” thick
- Fits wire .3125” to .375” dia
- Clear PVC

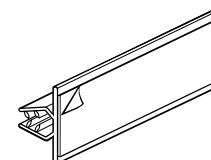

Item No.	Ref. No.	Dimensions	Fits	Pack
1810080809	-	1.25" H x 3" L	.1875"-.3875"	1

Additional lengths can be made to order (minimum quantities apply.)

SIGN HOLDERS

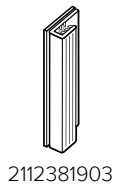
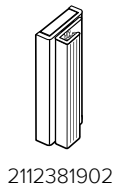
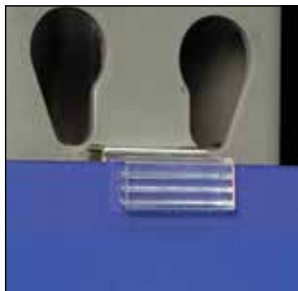

SuperGrip® Flush Magnetic Sign Holder 103

- SuperGrip® brand technology holds signs securely in the flush position
- Magnetic back installs quickly on most metal surfaces
- Standard or heavy-duty magnetic strength for extra holding power
- Holds .080" thick materials
- Clear PVC

Item No.	Ref. No.	Dimensions	Style	Pack
2112381901	-	1" L	Heavy-Duty	1
2112381902	-	3" L	Heavy-Duty	1
2112381903	-	3" L	Standard	1

Additional lengths and colors can be made to order (minimum quantities apply.)

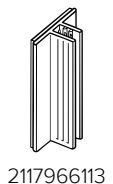
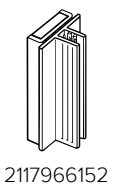

SuperGrip® Magnetic Sign Holder 110

- Wide base provides more stability for sign displays
- Magnetic back is effective on most metal surfaces
- Standard or heavy-duty magnetic strength for extra holding power
- SuperGrip® brand technology holds material up to .080" thick
- Clear PVC

Item No.	Ref. No.	Dimensions	Style	Pack
2117966151	-	1" W x 1" L	Heavy-Duty	1
2117966152	-	1" W x 3" L	Heavy-Duty	1
2117966113	-	1" W x 3" L	Standard	1

Additional lengths and colors can be made to order (minimum quantities apply.)

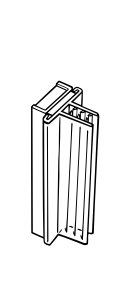

SuperGrip® Magnetic Heavy-Duty Sign Holder 114

- Heavy-duty sign holder displays thicker materials
- Magnetic back is effective on most metal surfaces; ideal for use on freezer cases, deli cases, and gondola or warehouse uprights
- Wider base increases stability
- SuperGrip® brand technology holds material .125" to .25" thick
- Clear PVC

Item No.	Ref. No.	Dimensions	Finish	Pack
2117966207	-	1" H x 3" L	Heavy-Duty	1

Additional lengths and colors can be made to order (minimum quantities apply.)

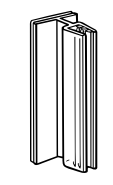
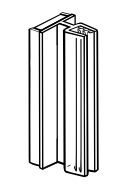

SuperGrip® Magnetic Sign Holder with Hinge

- For use on freezer cases, deli counters, gondolas, or warehouse uprights
- Allows you to add signs in the flag or upright position by attaching securely to most metal surfaces
- SuperGrip® technology provides superior holding power
- Standard or heavy-duty magnetic strength for extra holding power
- 3" L, holds materials up to .100" thick

Item No.	Ref. No.	Style	Capacity	Pack
2116126201	RFG2-027-3	Heavy-Duty	.100"	1
2112624102	RFG2-028-3	Standard	.100"	1

Additional lengths and colors can be made to order (minimum quantities apply.)

SuperGrip® Flag Sign Holder 128

- Features SuperGrip® brand holding power
- Flips up to move sign out of the way
- Fits .25" thick shelves
- Holds material up to .080" thick in flag position

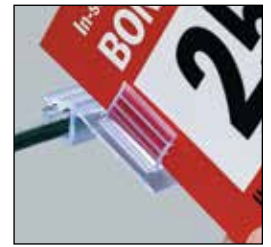
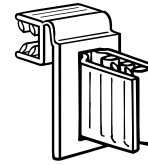

Item No.	Ref. No.	Dimensions	Finish	Pack
1814790800	-	.75" L	Clear PVC	1

Additional colors can be made to order (minimum quantities apply.)

SuperGrip® Sign Holder with Hinge 806

- Features SuperGrip® brand holding power for both the shelf and signage
- Flips up to move sign out of the way
- Fits .25" thick shelves
- Holds signs in flush position
- Holds signs up to .080" thick

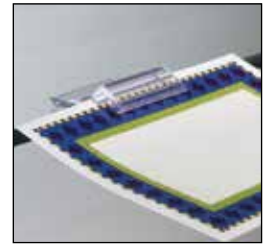
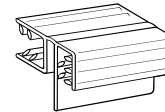

Item No.	Ref. No.	Dimensions	Finish	Pack
1817099701	RFG2-030-1	1" L	Clear PVC	1

Additional lengths and colors can be made to order (minimum quantities apply.)

Crystal Glass Shelf Sign Holder MD-1

- Nearly invisible while holding signs securely to thin glass shelves
- Holds signs above or below shelf at a slight angle for better visibility
- Fits .125" to .1875" thick glass shelves
- Holds material up to .010"
- Clear butyrate



Item No.	Ref. No.	Dimensions	Finish	Pack
1308169400	-	1" L	Clear	1

Additional lengths and colors can be made to order (minimum quantities apply.)

SuperGrip® Covered-Face Sign Holder 126

- SuperGrip® holding power securely grips shelf
- Fits shelves .1875" to .3125" thick; fits wire .3125" to .375" dia
- Holds signs 1.5" H x 3" L

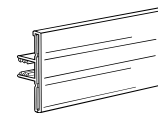

Item No.	Ref. No.	Dimensions	Finish	Pack
1810080800	-	1.5" H x 3" L	Clear PVC	1

Additional lengths can be made to order (minimum quantities apply.)

Crystal Glass Shelf Ticket Holder THG121

- Crystal-clear protection for tickets
- Fits .1875" to .25" thick glass shelves
- 1303709401: Angled face, clear PVC
- 1301794700: Vertical face, clear PETG



Item No.	Ref. No.	Label Dimensions	Finish	Pack
1303709401	-	.875" H x 2.875" L	Clear	1
1301794700	-	.875" H x 2" L	Clear	1

Additional lengths can be made to order (minimum quantities apply.)

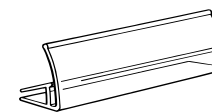

1303709401

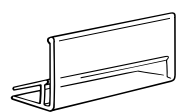

1301794700

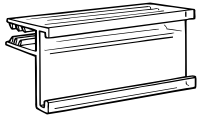

SuperGrip® Display-Trak

- C-Channel displays prices, UPC and other product information
- SuperGrip® holding power securely grips shelf
- Fits .25" thick shelves; holds 1.25" H tickets

Item No.	Ref. No.	Dimensions	Finish	Pack
1817469400	-	1.25" H x 2.5" L	Clear PVC	1

Additional lengths and colors can be made to order (minimum quantities apply.)



Angled Tag Molding

- Reversible molding clips over horizontal or vertical wire fencing, product stops or glass shelves
- Angles UPC tag up or downward for improved visibility
- Heavy-gauge construction is break-resistant
- Black plastic

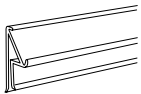

Vertical

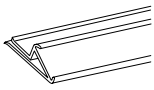

Horizontal

Item No.	Ref. No.	Dimensions	Finish	Pack
9920717339	-	1.25" H x 24" L	Black	1

Additional sizes and colors can be made to order (minimum quantities apply.)

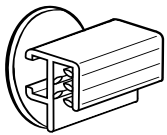

SuperGrip® Suction Cup Flush Sign Holder 121

- SuperGrip® brand technology holds signs in the flush position
- For use on glass surfaces, such as cooler doors
- Accepts material up to .080" thick
- Clear PVC sign holder / clear vinyl suction cup

Item No.	Ref. No.	Cup Dim.	Head Dim.	Pack
2112361502	RFG2-009-1	1" dia	1" L	1

Sign holder available in additional made to order lengths (minimum quantities apply.)



3.5" L with two suction cups

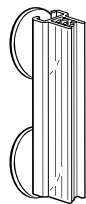

2118171119

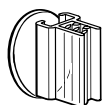

2112299302

SuperGrip® Suction Cup Flag Sign Holder 118

- SuperGrip® brand holding power holds signs in the flag position
- For use on glass surfaces, such as cooler doors
- Accepts material up to .080" thick
- Clear PVC sign holder / clear vinyl suction cup

Item No.	Ref. No.	Cup Dim.	Holder Dim.	Suction Cup	Pack
2112299302	-	1" dia	1" L	1	1
2118171102	RFG2-008-1	1.75" dia	1.75" L	1	1
2118171142	-	2.5" dia	1.75" L	1	1
2118171119	-	1.75" dia	3.5" L	2	1

Sign holder available in additional made to order lengths (minimum quantities apply.)

Clever Clip Suction Cup

- Swivel clip holds signs flush against vertical glass surfaces
- Versatile design allows clip to swivel and rotate
- Spring clip offers optimal holding power
- Holds up to .1875" thick material
- White polypropylene clip / clear vinyl suction cup

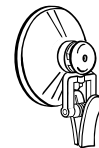

Item No.	Ref. No.	Cup Dim.	Pack
1500546303	-	1.75" dia	1

Suction Cup Clip-On Sign Holder 1803

- Attaches to glass surfaces
- Universal knuckles tilt and rotate from bottom and top
- Displays material up to .375" thick
- 4" L wire extender; 6.5" overall length
- 1.5" O.D. suction cup
- Clear plastic

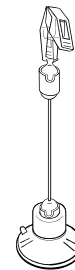

SIGN HOLDERS

Item No.	Ref. No.	Dimensions	Style	Pack
2806112901	-	6.5" L	White Knuckle	1

SuperGrip® Suction Cup 3-D Sign Holder

- Creates three-dimensional aisle signage
- Features SuperGrip® brand holding power
- Integrated suction cup attaches to glass surfaces
- Holds material up to .080" thick
- SuperGrip® tracks are 4" long and 2.5" apart
- 3.6875" W x 3.9375" H x .75" D
- Clear PVC

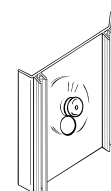

Item No.	Ref. No.	Dimensions	Finish	Pack
1812573901	-	3.6875" W x 3.9375" H	Clear	1

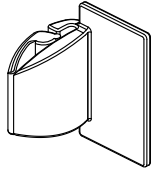

DragonClip™ Non-Piercing Adhesive - Flag

- Cam design does not damage or puncture signs.
- Clip area pressure fits signage to base for a strong hold.
- Attaches to clean flat surfaces with foam adhesive tape.
- Made of white 15% glass-filled nylon.
- Holds paper signs up to .0125" thick.

Item No.	Ref. No.	Dimensions	Finish	Pack
0405087060	RDC-F2	.875" W x 1.1" H x .75" D	White	100

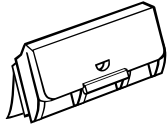

Fold•N•Hold® Flush Sign Holder with Adhesive

- Fold•N•Hold® brand technology punctures signs for a secure hold
- Attaches to flat surfaces with permanent adhesive
- Holds most paper signs up to .012" thick
- Natural polypropylene

Item No.	Ref. No.	Dimensions	Finish	Pack
2222247301	-	1.5625" W x .625" H	Natural	1

Additional colors can be made to order (minimum quantities apply.)

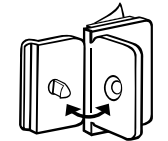
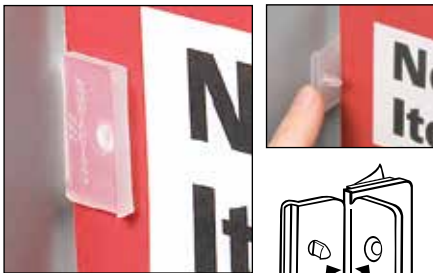

Fold•N•Hold® Flag Sign Holder with Adhesive FOF-104

- Fold•N•Hold® brand technology punctures signs for a secure hold
- Attaches to flat surfaces with permanent adhesive
- Holds most paper signs up to .012" thick in the prominent flag position
- Natural polypropylene

Item No.	Ref. No.	Dimensions	Finish	Pack
2227963601	-	1.125" W x .75" H x .5" D	Natural	1

Additional colors can be made to order (minimum quantities apply.)

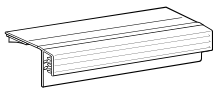

SuperGrip® Flip-Up Flush Sign Holder

- Add signage to shelves and counters
- Hinge allows sign to flip up
- Attaches with permanent adhesive
- SuperGrip® grippers hold signs up to .080" thick

Item No.	Ref. No.	Dimensions	Finish	Pack
4201674301	RFG2-034-3	3" L	Clear PVC	1

Additional lengths and colors can be made to order (minimum quantities apply.)

Front Load Plastic Sign Frame Rails

- Rails can be used singly or mitered to create custom sign frames
- Hinge allows easy sign placement, and snaps shut for a secure hold
- Attaches with permanent adhesive
- Holds signs up to .060" thick
- Silver, black or clear PVC



Item No.	Ref. No.	Dimensions	Finish	Pack
3702512701	-	48" L	Silver	1
3702512702	-	48" L	Black	1

Additional lengths, colors, and mitered Sign Frames, can be made to order (minimum quantities apply.)

Mercury™ Banner/Sign Holder with Adhesive

- Adheres to windows, walls and other surfaces with permanent adhesive
- Snaps shut to hold banners securely
- Holds paper, vinyl and fabric signs and banners up to .040" thick
- Use as a stabilizer at bottom of banner or mitered to create sign frame
- Clear or black PVC

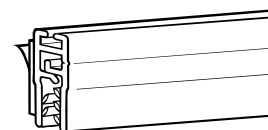
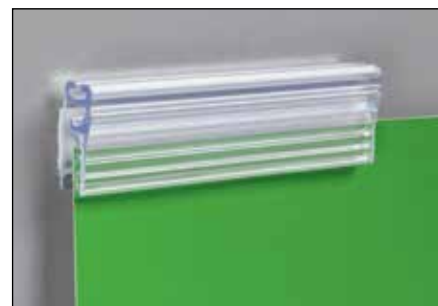

Item No.	Ref. No.	Dimensions	Finish	Pack
6112059101	-	3" L	Clear	1
6112059105	-	24" L	Clear	1
6112059104	-	48" L	Clear	1
6112059110	-	48" L	Black	1

Additional lengths, colors, and mitered Sign Frames, can be made to order (minimum quantities apply.)

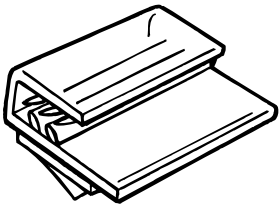
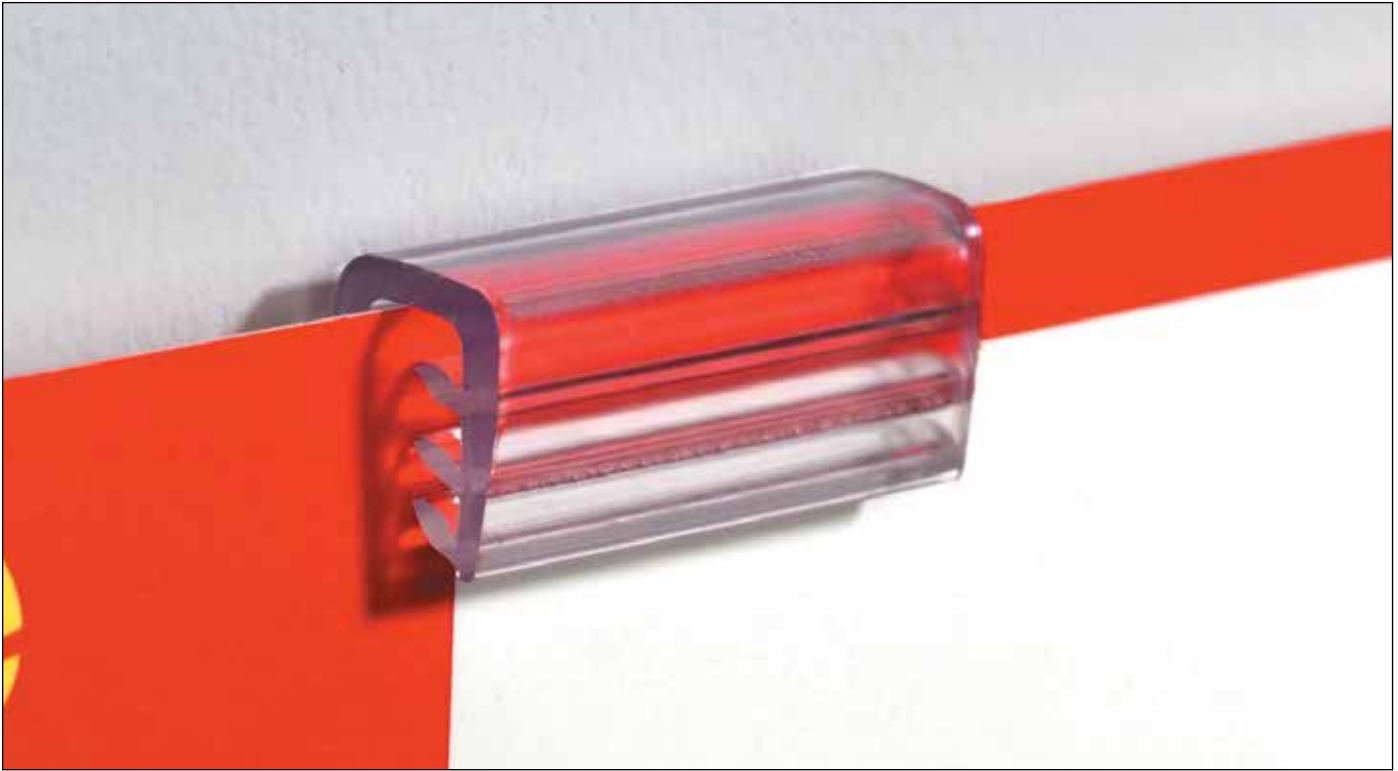

SuperGrip® Flush Sign Holder 103

- SuperGrip® brand technology holds signs securely in the flush position
- Attaches to flat surfaces with permanent adhesive
- Also available in magnet and reusable adhesive styles
- Two capacities accept material up to .080" thick or up to .25" thick
- Clear PVC

Item No.	Ref. No.	Dimensions	Capacity	Pack
2112381802	RFG2-004-1	1" L	.080"	1
2112381804	-	1.5" L	.080"	1
2113886701	-	1.5" L	.25"	1
2112381809	RFG2-004-3	3" L	.080"	1
2113886703	-	3" L	.25"	1
2112381817	-	48" L	.080"	1
2113886706	-	48" L	.25"	1

Additional lengths and colors can be made to order (minimum quantities apply.)

Tip-On Extruded Sign Holder 391

- Holds signs on case fronts, multi-deck cases, store shelves, etc.
- Attaches with permanent foam adhesive tape or clear adhesive
- Holds material up to .050" thick
- Clear PETG

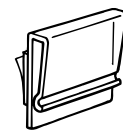

2607620201

Item No.	Ref. No.	Dimensions	Style	Pack
2607620201	-	Foam Tape	1" L	1
2607620206	-	Foam Tape	3" L	1
2607620209	-	Foam Tape	6" L	1
2607620213	-	Foam Tape	48" L	1
2607620239	-	Clear Adhesive	48" L	1

Additional lengths can be made to order (minimum quantities apply.)

All-Purpose Clip 2120

- Attaches to any flat surface with permanent adhesive – or, you can slide the clip over wireand use the adhesive to hold signs
- Materials slide easily into clip
- 300" I.D. for thicker materials
- 1" L
- White polystyrene

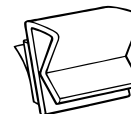

Item No.	Ref. No.	Dimensions	Finish	Pack
1507782200	RAPC-001-1	.300" I.D.	White	1

Additional lengths and colors can be made to order (minimum quantities apply.)



Adhesive Hanging Loop

- Simple peel-and-stick application
- Permanent adhesive back attaches loop to most surfaces
- .1875" loop accommodates #6 beaded chain
- Shown with Beaded Chain with A-Hooks
- White polystyrene



Item No.	Ref. No.	Dimensions	Finish	Pack
6407914301	-	.75" W x .75" L	White	1

Additional colors can be made to order (minimum quantities apply.)

SIGN HOLDERS



SuperGrip® Sign Holder with Hinge

- SuperGrip® brand technology holds signs in flag position
- Flexible hinge allows sign holder to flex when bumped
- Attaches with permanent white or clear adhesive or magnetic strip on base
- Wide base provides stability; 2116476001 has wider base
- Three capacities hold material up to .100", .125"-.1875", or .1875"-.25" thick
- 3" L, 22" L or 36" L
- Clear PVC



2112624101

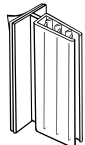

2116476001

Item No.	Ref. No.	Dim.	Capacity	Style	Pack
2112624101	RFG2-003-3	3" L	.100"	White Adh	1
2112624160	-	3" L	.100"	Clear Adh	1
2112624102	RFG2-028-3	3" L	.100"	Magnetic	1
2112624200	RFG2-003-3250	3" L	.125"-.1875"	White Adh	1
2116476001	-	3" L	.01875"-.25"	White Adh	1
2112624105	-	22" L	.100"	White Adh	1
2112624201	-	22" L	.125"-.1875"	White Adh	1
2112624137	-	36" L	.100"	White Adh	1
2112624202	-	36" L	.125"-.1875"	White Adh	1

Additional lengths and colors can be made to order (minimum quantities apply.)

SuperGrip® Flush Mount Sign Holder with Hinge

- SuperGrip® brand technology provides superior holding power
- Hinge allows signs to flex when bumped
- Attaches to flat surfaces with white permanent adhesive
- Holds materials up to .100" thick or .100"-.250" thick
- Clear PVC



2114380801



2111909301

Item No.	Ref. No.	Dim.	Capacity	Style	Pack
2114380801	-	3" L	.100"	White Adh	1
2111909301	-	3" L	.100"-.250"	White Adh	1

Additional lengths and colors can be made to order (minimum quantities apply.)

Perfect View™ SuperGrip® Sign Holder

- Two-piece unit angles for the perfect view
- SuperGrip® brand holder keeps signs securely in place
- Attaches with permanent adhesive
- Rotates a total of 80°
- Holds material up to .080" thick
- White PVC

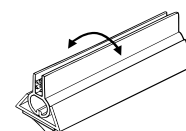

Item No.	Ref. No.	Dimensions	Finish	Pack
2160827201	-	1" H x 1.0625" W x 6" L	White	1

Additional lengths and colors can be made to order (minimum quantities apply.)

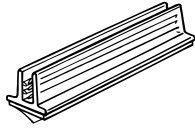

SuperGrip® Sign Holder 109

- Adheres to most flat surfaces using permanent or removable adhesive
- SuperGrip® brand technology holds material up to .080" thick
- 2117548204 has removable adhesive
- Clear PVC

Item No.	Ref. No.	Dimensions	Style	Pack
2117548202	RFG2-001-1	.4375" H x .5" W x 1" L	Perm	1
2117548204	-	.4375" H x .5" W x 1" L	Removable	1
2117548208	RFG2-001-3	.4375" H x .5" W x 3" L	Perm	1

Additional lengths and colors can be made to order (minimum quantities apply.)

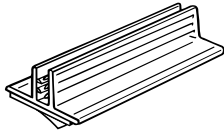

SuperGrip® Sign Holder 110

- Wider base offers more stability
- Attaches with white or clear permanent adhesive or white removable adhesive
- SuperGrip® brand technology holds material up to .080" thick
- 2117966104 has removable adhesive
- Clear PVC

Item No.	Ref. No.	Dimensions	Style	Adh. Color	Pack
2117966102	RFG2-002-1	.5" H x 1" W x 1" L	Perm	White	1
2117966104	-	.5" H x 1" W x 1" L	Removable	White	1
2117966106	RFG2-002-3	.5" H x 1" W x 3" L	Perm	White	1
2117966194	-	.5" H x 1" W x 3" L	Perm	Clear	1
2117966108	-	.5" H x 1" W x 6" L	Perm	White	1
2117966195	-	.5" H x 1" W x 6" L	Perm	Clear	1

Additional lengths and colors can be made to order (minimum quantities apply.)

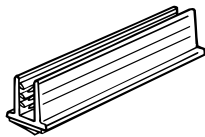

SuperGrip® Display Holder

- For holding thicker display materials
- Permanent adhesive base adheres to most flat surfaces
- SuperGrip® brand technology holds material .125" to .1875" thick
- Clear PVC

Item No.	Ref. No.	Dimensions	Finish	Pack
2117973011	-	.5" H x .5" W x 1.5" L	Clear	1
2117973012	-	.5" H x .5" W x 3" L	Clear	1
2117973013	-	.5" H x .5" W x 6" L	Clear	1

Additional lengths and colors can be made to order (minimum quantities apply.)

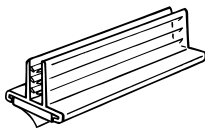

SuperGrip® Heavy-Duty Sign Holder 114

- SuperGrip® brand technology for thicker materials
- Wider base increases stability
- Permanent adhesive base adheres to most flat surfaces
- Holds material .125" to .25" thick
- Clear PVC

Item No.	Ref. No.	Dimensions	Finish	Pack
2117951802	RFG2-002-3250	.9375" H x 1" W x 3" L	Clear	1
2117951804	-	.9375" H x 1" W x 6" L	Clear	1

Additional lengths and colors can be made to order (minimum quantities apply.)

SuperGrip® Wide Base Sign Holder 113

- Holds larger signs horizontally, vertically, even upside down
- Wide base for improved stability
- Mounts with permanent adhesive
- Holds signs from .1875" to .25" thick
- Clear PVC

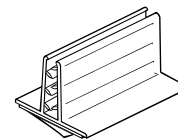
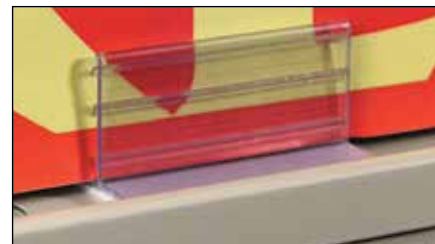

Item No.	Ref. No.	Dimensions	Finish	Pack
2110483902	-	1.25" H x 1.5" W x 3" L	Clear	1
2110483901	-	1.25" H x 1.5" W x 6" L	Clear	1

Additional lengths and colors can be made to order (minimum quantities apply.)

L-Style Sign Holder

- Displays signs on any flat surface
- Base affixes with permanent adhesive
- Channel allows signs to slide in and out quickly and easily
- Securely holds material up to .125" thick
- Clear butyrate

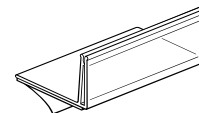

Item No.	Ref. No.	Dimensions	Finish	Pack
2161534902	-	1.5" H x 2" W x 3.5" L	Clear	1

Additional lengths and colors can be made to order (minimum quantities apply.)

BR & SK Card Holders

- Cards slide easily in and out
- Permanent adhesive base adheres to most flat surfaces
- Holds material up to .125" thick
- 2162283908 has .25" hole for fasteners to secure signs
- Clear PETG
- Clear butyrate (2167890801)

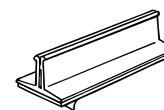

2162283901

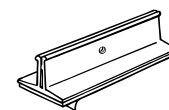

2162283908

Item No.	Ref. No.	Dimensions	Finish	Pack
2162283901	-	.875" H x 1.125" W x 3" L	Clear	1
2162283907	-	.875" H x 1.125" W x 6" L	Clear	1
2162283908	-	.875" H x 1.125" W x 6" L	Clear	1

Additional lengths and colors can be made to order (minimum quantities apply.)

Econo BR Card Holder

- Cards slide easily into holder
- Permanent adhesive base adheres to most flat surfaces
- Holds materials up to .125" thick
- 875" H x 1.125" W
- Clear PVC

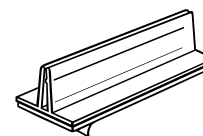

Item No.	Ref. No.	Dimensions	Finish	Pack
2162284001	-	3" L	Clear	1
2162284002	-	6" L	Clear	1

Additional colors can be made to order (minimum quantities apply.)

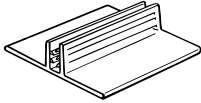
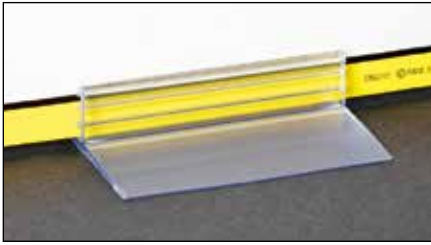

SuperGrip® Extra Wide Base Sign Holder

- Wide base offers stability for cards and signs
- SuperGrip® brand technology holds material up to .080" thick
- Clear PVC

Item No.	Ref. No.	Dimensions	Finish	Pack
2111109201	RFG2-026-2	.5" H x 2" W x 2" L	Clear	1

Additional colors can be made to order (minimum quantities apply.)

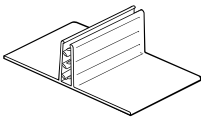
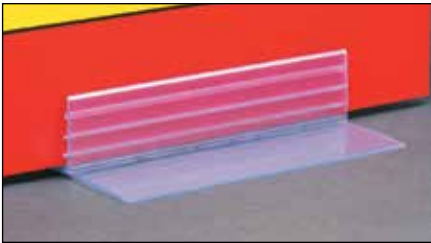

SuperGrip® T-Style Table-Top Sign Holder

- SuperGrip® brand technology displays table-top signage securely
- Holds material .1875" to .25" thick
- Clear PVC

Item No.	Ref. No.	Dimensions	Finish	Pack
2110705201	-	4" W x 3" L	Clear	1
2110705202	-	4" W x 6" L	Clear	1

Additional lengths and colors can be made to order (minimum quantities apply.)

SuperGrip® L-Style Table-Top Sign Holder

- SuperGrip® brand technology displays shelf or table-top signage securely
- Use multiple holders for longer shelf signs or headers
- Holds material .1875" to .25" thick
- Slotted holes for mounting with fasteners
- Clear PVC

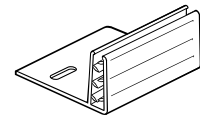

Item No.	Ref. No.	Dimensions	Finish	Pack
2117614101	-	3" L	Clear	1

Easel Card Holder

- Display pricing and promotional messages in the deli, bakery, seafood or other departments
- Easel back design can slide underneath bowls, trays, pans or fixtures, or stand alone
- Accepts rigid material up to .025" thick
- Clear PVC

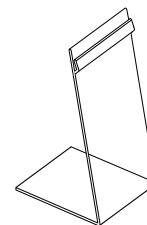

2165828401

Item No.	Ref. No.	Dimensions	Finish	Pack
2160561601	-	5" H x 2" W	Clear	1
2163380601	-	3" H x 2" W	Clear	1
2165828401	-	5" H x 2" W	Clear	1

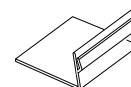

2160561601



Magnetic Adjustable Sign Holder 4333

- Holds signs securely to most metal surfaces
- Tilts back for better viewing angles
- Holds material up to .25" thick
- 1.5" W x 3" L base
- Clear with white base
- **WARNING:** Do not use near sensitive electronic equipment

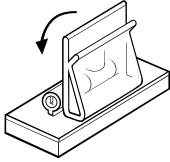

Item No.	Ref. No.	Dimensions	Finish	Pack
2802084701	-	1.5" W x 3" L	Clear	1

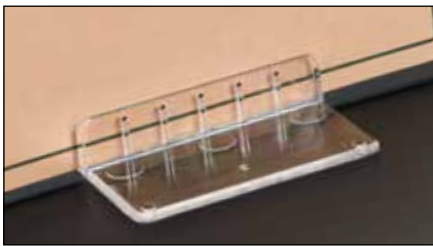
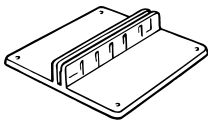

Table Top Card Holder 2230

- Attractive card holder features ribbed design to hold signs securely
- Holds paper up to .036" thick; not recommended for plastic signs
- Custom imprinting available (minimum order required)
- Clear polystyrene



Item No.	Ref. No.	Dimensions	Finish	Pack
2162507001	-	2" W x 1.75" L	Clear	1

Easel Card Holder 2231

- Easel-back design for better viewing angle
- Excellent for counter tops and display cases
- Holds material up to .036" thick; not recommended for plastic signs
- Clear polystyrene

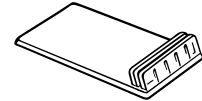
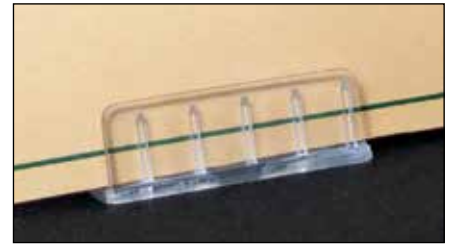

Item No.	Ref. No.	Dimensions	Finish	Pack
2166395300	-	.5" H x 1.5625" W x 2.375" D	Clear	1

Counter Top Adjustable Sign Holder 2806

- Unique hinge lets you tilt signs back for better viewing angles
- Holds material from .008" to .020" thick
- 1.1875" W x 1.5" L concave base
- Clear plastic

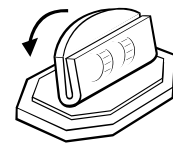

Item No.	Ref. No.	Dimensions	Finish	Pack
2802106900	-	1.1875" W x 1.5" L x .75" H	Clear	1

SIGN HOLDERS

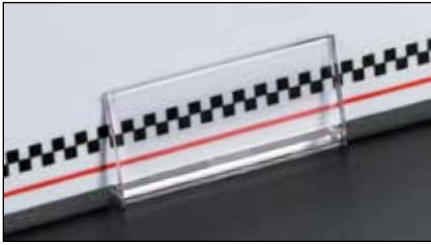

Crystal Easel Ticket Holder THE201

- Durable holder with a glass-like appearance
- Easel design adds stability and display flair
- Holds material up to .080" thick
- Clear PVC

Item No.	Ref. No.	Dimensions	Finish	Pack
2161722400	-	1.25" L x 1" D	Clear	1

Additional lengths can be made to order (minimum quantities apply.)

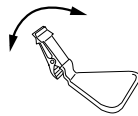
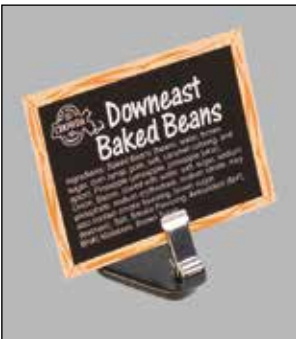

Weighted Base Flat Sign Holder

- Weighted base keeps sign holder upright
- Snap clip ensures a tight grip on signs
- Rust-proof stainless steel for durability
- Triangular base measures 1.75" W x 1.75" L x 1.75" H
- Stainless steel with black vinyl-coated steel base

Item No.	Ref. No.	Dimensions	Finish	Pack
9920711650	-	1.75" H	Black	1

Additional colors can be made to order (minimum quantities apply.)



9920714447



9920710126

Black Weighted Base European-Style Sign Holders

- Heavy weighted base keeps holders upright
- Resists rusting and corroding in damp environments
- Available with gator clip or clear card holder strip clip
- Black zinc-coated steel

Item No.	Ref. No.	Style	Dimensions	Pack
9920715460	-	Gator Clip	3" H	1
9920714447	-	Gator Clip	6" H	1
9920710126	-	Card Holder Strip	3" H	1
9920712071	-	Card Holder Strip	6" H	1

Additional sizes and styles can be made to order (minimum quantities apply.)



9920719670

Harp Clip Sign Holder

- European-style "harp" clips add a touch of class to any hot or cold food display
- Heavy weighted base is very stable
- Stainless steel

Item No.	Ref. No.	Dimensions	Finish	Pack
9920719670	-	1.5" H	Silver	1
9920713708	-	6" H	Silver	1

Additional sizes can be made to order (minimum quantities apply.)

Stainless Steel Card Holder

- Ideal for calling attention to specialty items, display ingredient cards, etc.
- Wire ring top holds sign tags securely
- Weighted base measures 2.625" (6.7 cm)
- Stainless steel, deluxe electro-polished finish

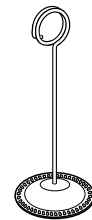

Item No.	Ref. No.	Dimensions	Finish	Pack
9920716994	-	6" H	Silver	1

Additional sizes can be made to order (minimum quantities apply.)

Spiral Base Card Holders

- Add a fun touch to any display and put a new twist on a traditional look
- Suitable for use in hot cases
- Various-height holders allow you to consistently sign multiple areas
- Split ring top holds tag securely
- Black or chrome powder-coated steel



Item No.	Ref. No.	Dimensions	Finish	Pack
9920717691	-	1.75" H	Black	1
9920716818	-	5" H	Black	1
9920714252	-	7" H	Black	1
9920715326	-	4" H	Chrome	1
9920710456	-	6" H	Chrome	1

Additional sizes and colors can be made to order (minimum quantities apply.)

SIGN HOLDERS



new

PATENTED

SIGN HOLDERS



BEFORE



AFTER

Allura™ LED Backlit Data Strip®

The Allura™ LED Data Strip® illuminates the shelf edge as well as the product below. This integrated solution draws customer attention to shelf edge messaging while enhancing the appearance of merchandise on the shelf. This is achieved by utilizing a single, ultra-thin LED light bar (included) to light up both the Data Strip and the product below. The clear, plastic Data Strip that snaps into standard 48” retail shelf channels.

The Allura™ LED Data Strip® also features an additional channel to hold another 48” ultra-thin LED light bar for added product illumination. No assembly or special tools required. To install, snap the LED Data Strip into the price channel. Utilize backlit graphics that insert securely behind the front lens of the Data Strip to promote products, brands, or promotions. The Allura™ LED Data Strip® is a re-useable and effective way for retailers to draw customer attention and increase sales.

- Snap-in, backlit Data-Strip® with protective graphic lens
- Includes 48” long Allura™ Ultra-Slim LED Light Bar
- Features second channel for additional light bar installation
- No tools required
- Powered by Allura Bus Bar or Spider Cables connected to a Power Supply*



Lumen

450/ft



Low Voltage

24v

Light Color

Temperature

4200k



Color

Render Index

80+



Beam Width

120°



Lifetime

50k Hrs



Waterproof

No



Watts

2.93/ft

Item No.	Description	Length	Material
6800400046	48” Allura™ Data Strip®	48” L x 1.25” H	Clear Plastic

Data Strip® SuperGrip® Flag Sign Holder 604

- Clips onto window of Economy Data Strip® Label Holders
- Holds signs securely in the flag position
- Features SuperGrip® brand holding power
- Holds material up to .080" thick

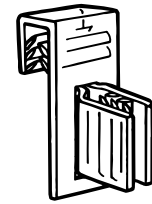

Item No.	Ref. No.	Dimensions	Finish	Pack
0212483001	RFG2-010	.75" W x 1.5" H	Clear PVC	1

Data Strip® SuperGrip® Universal Flag Sign Holder DSG4

- Fits most Data Strip® Label Holders, holding signs securely in the flag position
- Hinge lets you flip the sign for scanning or restocking
- Holds signs up to .080" thick
- Features SuperGrip® brand holding power

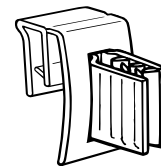

Item No.	Ref. No.	Dimensions	Finish	Pack
4407698801	RFG2-023-75	.75" W x 1" H	Clear PVC	1

Data Strip® Economy Hinged Flag Sign Holder DSGE-2H

- Clips to most Economy Data Strip® Label Holders
- Hinge lets you flip the sign for scanning or restocking
- Holds signs up to .080" thick in the flag position
- Features SuperGrip® brand holding power



Item No.	Ref. No.	Dimensions	Finish	Pack
0213327600	RFG2-029-75	.75" W x 1" H	Clear PVC	1

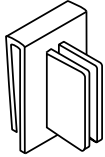

Clip-on Sign Holders for Windowed Price Channel

- Designed to work with any extruded price channel.
- Clip securely attaches to the front lens, providing an uncluttered appearance.

Item No.	Ref. No.	Dimensions	Finish	Pack
0406395203	RJK-SH	1.25" H x .75" W x .75" D	Trans.	100

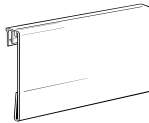

Data Strip® Universal Hinged Covered-Face Sign Holder

- Holds signs securely in the flush position, protected behind full-face window
- Hinge lets you flip the sign for scanning or restocking
- Fits most Data Strip® Label Holders
- Holds 3.5" H x 5.5" L signs

Item No.	Ref. No.	Dimensions	Finish	Pack
4402967601	-	3.5" H x 5.5" L	Clear PVC	1

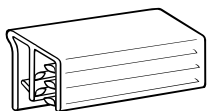

Data Strip® SuperGrip® Universal Flush Sign Holder DSG3

- Fits most Data Strip® Label Holders, holding signs securely in the flush position
- Holds signs up to .080" thick
- Features SuperGrip® brand holding power

Item No.	Ref. No.	Dimensions	Finish	Pack
4400669101	RFG2-014	1" L	Clear PVC	1

Data Strip® SuperGrip® Economy Hinged Flush Sign Holder DSGE1H

- Clips directly onto most Economy Data Strip® Label Holders
- Hinge lets you flip up the sign, revealing UPC scanning information underneath
- Flip sign out of the way when restocking shelves
- Holds signs up to .080" thick in the flush position
- Features SuperGrip® brand holding power

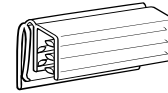

Item No.	Ref. No.	Dimensions	Finish	Pack
1818823101	RFG2-031-1	1" L	Clear PVC	1

Data Strip® SuperGrip® Economy Flush Sign Holder DSGE-150

- Clips directly onto all Economy Data Strip® Label Holders, holding signs and tickets flush
- Features reverse angle grippers for secure holding power
- Holds signs up to .080" thick

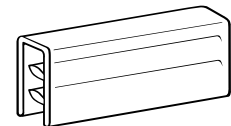

Item No.	Ref. No.	Dimensions	Finish	Pack
0214216701	RFG2-018-150	1.5" L	Clear PVC	1

Flip-Up Sign Holder for Shelf Channel

- Integrated hinge flips up to allow access to product below
- Channel mount fits most standard 1.25" H shelf channels
- Holds and protects signs 3.5" H
- Available in two lengths
- Clear PVC

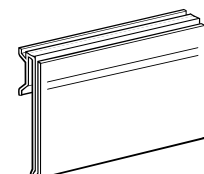

Item No.	Ref. No.	Dimensions	Finish	Pack
4203891701	-	3.5" H x 5.5" L	Clear	1
4203891702	-	3.5" H x 47.625" L	Clear	1

Additional lengths can be made to order (minimum quantities apply.)

SIGN HOLDERS

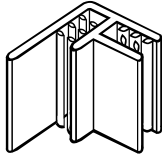

SuperGrip® Flag Sign Holder for Scan Plate

- SuperGrip® grippers hold scan plate, Data Strip® Label Holder and signage securely
- Fits scan plates with label holder up to .120" thick
- Holds signs up to .080" thick
- Shown with DS-MSP Data Strip® Label Holder for Metal Scan Plate
- Clear PVC

Item No.	Ref. No.	Dimensions	Finish	Pack
1811888801	RFG2-017-75	.75" H	Clear	1

Additional lengths can be made to order (minimum quantities apply.)

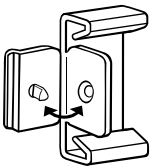

Fold•N•Hold® Flag Sign Holder for Scan Plate FOS-104

- Fold•N•Hold® technology punctures signs for a secure hold
- Slides onto 1.280" to 1.375" H metal and plastic scan plates
- Holds most paper signs up to .012" thick in the flag position
- Natural polypropylene

Item No.	Ref. No.	Dimensions	Finish	Pack
2221888801	-	1.5" H	Natural	1

Additional colors can be made to order (minimum quantities apply.)

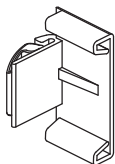

DragonClip™ Non-Piercing for Scan Plate

- Holds signage in the flag position.
- Cam design does not damage or puncture signage.
- Clips on plastic or metal scan plates without interfering with price label.
- Holds up to .125" thick signs.; fits on our 1.375" H x .045" thick scan plates.
- Cam design strongly grips signs; holds up to .0125" thick signs.

Item No.	Ref. No.	Dimensions	Finish	Pack
0402556888	RDC-F7	1.475" H x .95" W x .75" D	White	100

SuperGrip® Shovel Base Sign Holder

- Insert shovel base between merchandise to keep sign holder in place
- Also, place sign holder on shelf under displayed product
- SuperGrip® brand technology securely holds signs up to .080" thick

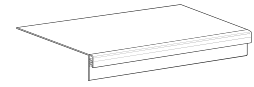

Item No.	Ref. No.	Dimensions	Finish	Pack
1511223401	-	4.5" D x 11" L	Clear PVC	1

Additional lengths and colors can be made to order (minimum quantities apply.)

SuperGrip® Sign Gripper

- Two-way grippers hold signs in flag or flush position
- SuperGrip® brand technology holds fixtures and signs up to .080" securely
- Attaches to most shelving, uprights or wire
- Duo-Grip model has S-shape profile; Two-Way model has 90° profile
- Clear PVC



1811876800

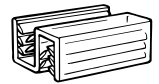

1818047800

SIGN HOLDERS

Item No.	Ref. No.	Style	Dimensions	Pack
1818047800	RFG2-012-1	Duo-Grip	1" L	1
1811876800	-	Two-Way	1" L	1

Additional lengths and colors can be made to order (minimum quantities apply.)

Metal Cap and Stand-Off Set

- Ideal for large sized boards, panels or acrylic pieces
- Each set contains metal stand-off and cap, two clear washers, and screw for cap (wall mount screw not included)
- 75" or 1.125" diameter
- Chrome-finished steel and silver brushed aluminum styles are heavy-duty; satin stainless steel styles have one-piece stand-off

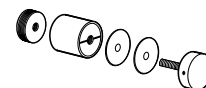

8200000001

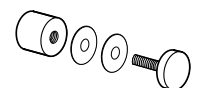

8200350176

Removed 5/18/23

Item No.	Ref. No.	Style	Dimensions	Pack
8200000001	-	Chrome	1.125" dia x 1" D	1 Set
8200000110	-	Aluminum	.75" dia x 1" D	1 Set
8200350171	-	Satin Stainless Steel	.75" dia x 1" D	1 Set
8200350176	-	Satin Stainless Steel	1.125" dia x 1" D	1 Set

Additional sizes and colors can be made to order (minimum quantities apply.)

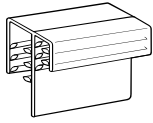

8118842802

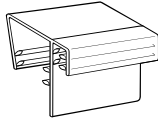

1810000000

SuperGrip® Display Sign Holder

- SuperGrip® brand technology holds materials securely
- 8118842802 ideal for holding signs flush on acrylic or corrugated material; 1810000000 ideal for use on wood fixtures
- 8118842802: one side holds material up to .080" thick, other side holds .170" thick material
- 1810000000: one side holds material up to .080" thick, other side holds .750" thick material
- Clear PVC

Item No.	Ref. No.	Capacity	Dimensions	Pack
8118842802	RFG2-021-150	.080"/.170"	1.5" L	1
1810000000	-	.080"/.750"	1.5" L	1

Additional lengths and colors can be made to order (minimum quantities apply.)

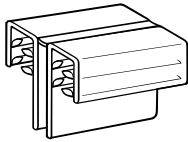

SuperGrip® Hinged Panel/Sign Holder

- Features SuperGrip® brand holding power for displays and signs
- Holds signs flush on acrylic or corrugated material
- Both sides hold material .015" to .250" thick
- Clear PVC

Item No.	Ref. No.	Dimensions	Finish	Pack
1511031801	-	1" L	Clear	1

Additional lengths and colors can be made to order (minimum quantities apply.)

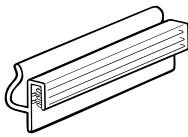

SuperGrip® Flush Sign Holder for Slatwall

- Add promotional signage to standard slatwall
- SuperGrip® brand technology provides superior holding power
- Fits most standard slatwall and can be repositioned
- Holds signs up to .080" thick
- Clear PVC

Item No.	Ref. No.	Dimensions	Finish	Pack
1514519402	RFG2-020-3	3" L x 1" H	Clear	1

Additional lengths can be made to order (minimum quantities apply.)

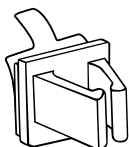

Pen/Wire Clip PW-85E

- Attaches pens and pencils to warehouse shelves, cash registers, or just about anywhere
- Permanent adhesive base
- Also fits wire up to .313" diameter for use as a sign holder
- White polypropylene

Item No.	Ref. No.	Dimensions	Finish	Pack
1501949900	-	.5" H x .5" W	White	1

Additional colors can be made to order (minimum quantities apply.)

Versa-Clip® Coupon Holder FKA-88

- Holds coupon pads directly from shelf channels for easy customer access
- Not recommended for chipboard or particle board
- Clear 15 mil PVC
- Sold in full rolls or sheets only

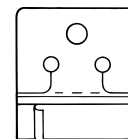

Item No.	Ref. No.	Dimensions	Finish	Pack
5207512901	RHT-9001-CP	1.71" W x 1.88" H	Clear	2,000/roll
5207512902	RHT-9002-CP	1.71" W x 1.88" H	Clear	16/sheet

Versa-Clip® Coupon Holder with Clear Liner FKA-88CL

- Clips directly to shelf channels or most flat surfaces
- Clear adhesive holds to most surfaces
- Not recommended for chipboard or particle board
- Sold in full rolls or sheets only

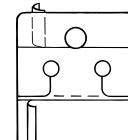

Item No.	Ref. No.	Dimensions	Finish	Pack
5207512903	-	1.71" W x 1.88" H	Clear	2,000/roll
5207512904	-	1.71" W x 1.88" H	Clear	16/sheet

Versa-Clip® Coupon Holder for Wire FKA-85W

- Can be used on wire up to .1875" diameter, as well as shelf channels
- Adhesive on both sides
- Not recommended for chipboard or particle board
- Clear 20 mil PVC
- Sold in full rolls or sheets only

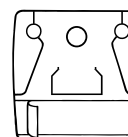

Item No.	Ref. No.	Dimensions	Finish	Pack
5201962501	-	1.969" W x 1.875" H	Clear	1,800/roll
5201962502	-	1.969" W x 1.875" H	Clear	18/sheet

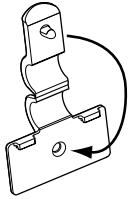

Fold•N•Hold® Flush Sign Holder for Wire FO-301

- Fold•N•Hold® technology punctures sign for a secure signage solution
- Ideal for low temperature environments
- Fits wire up to .375" dia.; holds most paper signs up to .012" thick
- Compatible with vinyl pouch sign holder kits
- Natural polypropylene

Item No.	Ref. No.	Dimensions	Finish	Pack
1226279701	-	1.5" W	Natural	250

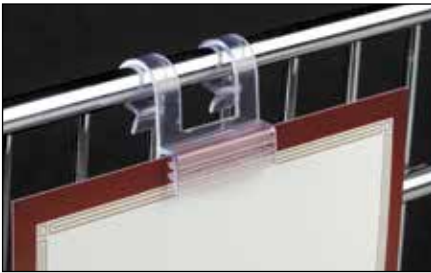

1118108102

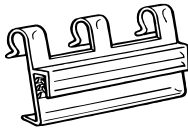

1118108103

SuperGrip® Wire Sign Holder 101

- SuperGrip® brand technology holds signs securely in the flush position
- Clips easily over wire up to .375" diameter
- 1.375" wide holder includes two hooks
- 2.5" wide holder includes three hooks
- Holds materials up to .080" thick

Item No.	Ref. No.	Dimensions	Finish	Pack
1118108102	RFG2-015	1.375" W	Clear PVC	1
1118108103	-	2.5" W	Clea PVC	1



SuperGrip® Hanging Wire Flag Sign Holder 401

- SuperGrip® brand technology holds signs securely in flag position
- Fully assembled
- Clips easily over wire up to .375" diameter
- Holds materials up to .080" thick

Item No.	Ref. No.	Dimensions	Finish	Pack
1117574701	RFG2-022-1	1" W	Clear PVC	1

Additional colors can be made to order (minimum quantities apply.)

SuperGrip® Wire Flush Sign Holder 301

- SuperGrip® brand technology holds signs securely in flush position
- Clips easily over wire up to .375" diameter
- Holds materials up to .080" thick

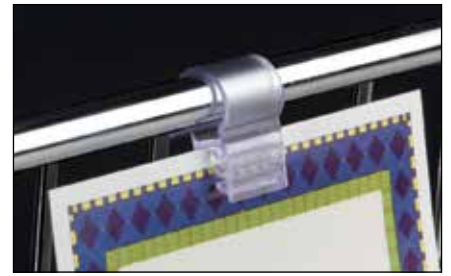

Item No.	Ref. No.	Dimensions	Finish	Pack
112148301	-	.5" L	Clear PVC	1
112148303	R17-718-1/2	1" L	Clear PVC	1

Additional lengths and colors can be made to order (minimum quantities apply.)

SuperGrip® Hinged Flag Sign Holder for Wire

- SuperGrip® brand technology holds signs securely
- Integrated hinge allows signs to flex when bumped
- Clip-on design attaches to wire .150" to .165" diameter
- Holds material up to .080" thick

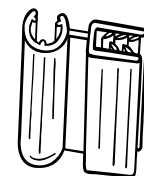
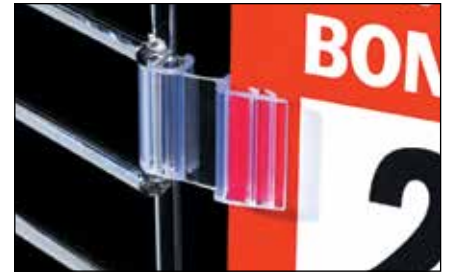

Item No.	Ref. No.	Dimensions	Finish	Pack
115110201	-	.75" L	Clear PVC	1

Additional lengths and colors can be made to order (minimum quantities apply.)

SuperGrip® Hinged Flush Sign Holder for Wire

- SuperGrip® brand technology provides superior holding power
- Integrated flexible hinge allows sign to flip up
- Clip-on design attaches to wire up to .375" diameter as well as bins and deli pans
- Holds material up to .080" thick
- Clear PVC

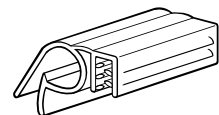

Item No.	Ref. No.	Dimensions	Finish	Pack
117653603	-	1.5" L	Clear	1

Additional lengths and colors can be made to order (minimum quantities apply.)

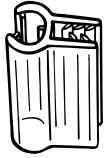

SuperGrip® Wire Flag Sign Holder 120/123

- SuperGrip® brand technology holds signs at a variety of viewing angles
- Gripping ribs prevent sign from rotating on wire
- Holds material up to .080" thick
- Style 120 (111431202) fits .200" diameter wire
- Style 123 (111431200) fits .250" diameter wire
- Clear PVC

Item No.	Ref. No.	Dimensions	Fits Wire	Pack
111431202	RFG2-013-200	1" L	.200" dia	1
111431200	RFG2-013-250	1" L	.250" dia	1

Additional lengths and colors can be made to order (minimum quantities apply.)

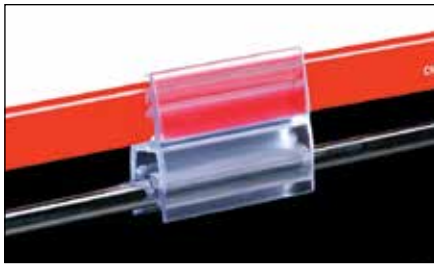

SuperGrip® H Clip 111

- Attach signs above displays or fixtures
- SuperGrip® brand technology holds signs and fixtures securely
- 8117602701 and 02 fit .080" diameter wire
- 8117602703 fits .125" diameter wire
- Clear PVC

Item No.	Ref. No.	Dimensions	Capacity	Pack
8117602701	RFG2-024-1	1" L	.080"	1
8117602702	RFG2-024-3	3" L	.080"	1
8117602703	RFG2-025-1	1" L	.125"	1

Additional lengths and colors can be made to order (minimum quantities apply.)

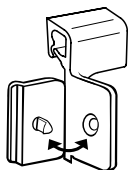

Fold•N•Hold® Data Strip® Flag Sign Holder

- Features siffon's Fold•N•Hold® technology, this sign holder punctures signs securely and displays them in the flag position
- Fits most Data Strip® Label Holders and Front Fences
- Holds paper signs up to .012" thick
- Natural polypropylene

Item No.	Ref. No.	Dimensions	Finish	Pack
2226166201	-	.75" W x 1.25" H	Natural	1

Covered-Face Sign Holder for Wire

- Covered face protects signage from dust and spills
- Attaches to .188" to .313" diameter wire
- Holds 3.5" H x 5.5" L signs
- Clear PVC

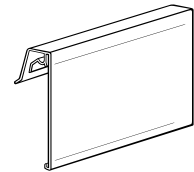

Item No.	Ref. No.	Dimensions	Finish	Pack
0405266701	-	3.5" H x 5.5" L	Clear	1

Additional lengths can be made to order (minimum quantities apply.)

Multi-Mount Covered-Face Sign Holder

- Single signage solution for multiple fixture styles throughout the store
- Fits most 1.25" H shelf channels, wire fixtures up to .375" diameter, and panel thicknesses of .080" to .250"
- Holds 3.5" H x 5.5" L signs
- Clear butyrate

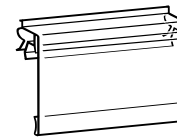

Item No.	Ref. No.	Dimensions	Finish	Pack
0400542202	-	3.5" H x 5.5" L	Clear	1

Additional colors can be made to order (minimum quantities apply.)

Basket / Fencing Sign Holder

- Easily clips onto wire baskets or fencing.
- Holds standard sign sizes.
- Also clips onto bottom of standard shelf channel.
- Clear front allows your message to be seen easily.

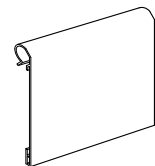

Item No.	Ref. No.	Dimensions	Finish	Pack
0401607209	RCH-350-275	3.5" H x 2.75" W	Clear	100
0408154317	RCH-350-550	3.5" H x 5.5" W	Clear	100

Freezer Grid Sign Holder

- Available graphic space: 3.5" H x 11" W
- Reuseable
- Easy to use
- No tools required to install
- Grab customer attention



Item No.	Ref. No.	Dimensions	Finish	Pack
4433581101	-	6" H x 11" W	Clear	10

SIGN HOLDERS

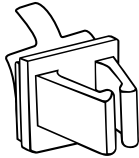
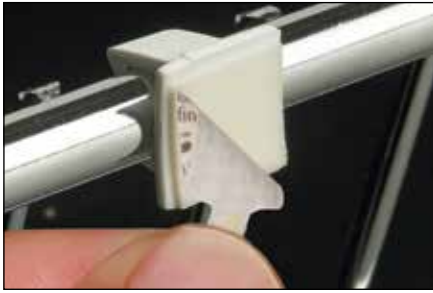

Pen/Wire Clip PW-85E

- Clips over wire and holds signs with permanent adhesive
- Fits wire up to .313" diameter
- White polypropylene

Item No.	Ref. No.	Dimensions	Finish	Pack
1501949900	-	.5" H x .5" W	White	1

Additional colors can be made to order (minimum quantities apply.)

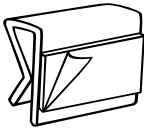

All-Purpose Clip 2120

- Clips over wire and holds signs, displays or literature holders with permanent adhesive
- Fits up to .300" diameter wire
- White polystyrene

Item No.	Ref. No.	Dimensions	Finish	Pack
1507782200	RAPC-001-0	1" L	White	1

Additional lengths and colors can be made to order (minimum quantities apply.)



Clever Clip

- Swiveling clip holds just about anything
- Versatile design allows clip to swivel and rotate
- Spring clip offers optimal holding power
- Fits up to .375" diameter wire
- Holds up to .1875" thick material
- White polypropylene

Item No.	Ref. No.	Dimensions	Finish	Pack
1500546301	-	1" L	White	1

Additional colors can be made to order (minimum quantities apply.)

Vinyl Pouch Sign Holder Kits

- Kits combine the secure hold of Fold•N•Hold® sign holders with the protection of a vinyl pouch
- Fold•N•Hold® sign holders puncture through mounting holes for the most secure hold
- Vinyl pouch with mounting holes protects signs; opens from the bottom for easy sign change
- Two vinyl pouch sizes for signs up to 2" x 3" and 3" x 4"
- Sign holders mount to gondola shelves in the flush or flag position
- Fold•N•Hold® Shelf Channel Flush Sign Holder FO-102 fits standard 1.25" shelf channels and holds signs in the flush position
- Fold•N•Hold® Flag Sign Holder for Perforated Shelves FO-304 fits most standard perforated shelves and displays signs in the flag position
- Fold•N•Hold® Flush Sign Holder for Perforated Shelves FO-119 fits most standard perforated shelves and displays signs in the flush position
- Natural polypropylene sign holders / clear vinyl pouch

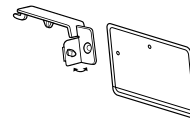

3220000101

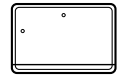

3207337331

Item No.	Ref. No.	Kit	Pouch Dim.	Pack
3220000101	-	FO-304	3" x 4"	1
3207337331	-	Pouch only	3" x 4"	1

Additional sizes can be made to order (minimum quantities apply).

Vinyl Pouch with Mounting Holes V701

- Protective pouch opens from the side and holds tags up to 1.25" H x 5" L
- Multiple hanging options available including Rings and Locking Straps
- Shown with Overlap Ring J-1901 1601799801
- Clear vinyl



Item No.	Ref. No.	Dimensions	Finish	Pack
1408084901	-	1.25" H x 5" L	Clear	1

Additional sizes can be made to order (minimum quantities apply).

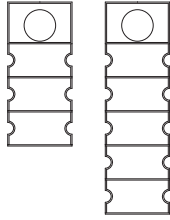

Hanging Vinyl Multi-Pockets R16

- Designed and manufactured with high-quality PVC with UV inhibitors to prevent discoloration.
- Heat-welded grommet - single hole on all sizes (except 3 holes for 8.5" x 11" sizes).
- Custom sizes available. Call for details.

Item No.	Ref. No.	Dimensions	Finish	Pack
4436640548	R16-453-T3	3.125" W x 6" H, 1.25" x 3" pockets	Clear	100
4430312861	R16-453-T5	3.125" W x 8.5" H, 1.2" x 3" pockets	Clear	100

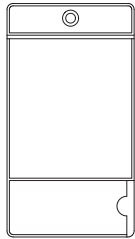

Hanging Vinyl Pocket with Tag Holder

- Designed and manufactured with high-quality PVC with UV inhibitors to prevent discoloration.
- Heat-welded grommet - single hole
- Custom sizes available. Call for details.

Item No.	Ref. No.	Dimensions	Finish	Pack
1506390944	R-VMP-0335	3" x 3.5" and 3" x 1.25" pockets	Clear	25

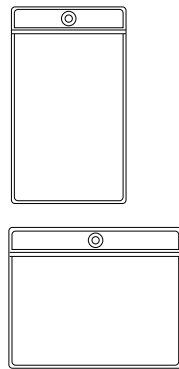

Hanging Vinyl Pockets

- Designed and manufactured with high-quality PVC with UV inhibitors to prevent discoloration.
- Heat-welded grommet - single hole on all sizes (except 3 holes for 8.5" x 11" sizes).
- Custom sizes available. Call for details.

Item No.	Ref. No.	Dimensions	Finish	Pack
3207532100	-	3" W x 5" H	Clear	1
1500269715	R-HVP-5535	5.5" W x 3.5" H	Clear	25
1507157881	R-HVP-0507	5" W x 7" H	Clear	25
1507832736	R-HVP-0705	7" W x 5" H	Clear	25
1507020629	R-HVP-0406	4" W x 6" H	Clear	25
1503325973	R-HVP-0604	6" W x 4" H	Clear	25
1508189297	R-HVP-8511	8.5" W x 11" H	Clear	25

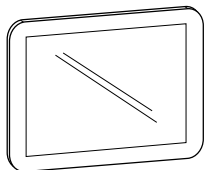

Counter Mat Sign Holder

- Display promotions on counters and other flat surfaces
- Reusable mat protects paper signs, which slide easily into the sign holder window
- Holds signs in vertical or horizontal orientation
- Backed with heavy-duty rubber non-slip backing to hold to surfaces
- 10.5" x 13" for 8.5" x 11" signs; 13" x 19" for 11" x 17" signs
- Signs are framed in a black border; 15 mil scratch-resistant vinyl

Item No.	Ref. No.	Dimensions	Pack
2162348701	-	8.5" x 11"	1
2162348702	-	11" x 17"	1

Additional colors can be made to order (minimum quantities apply.)

Adhesive and Magnetic Vinyl Pockets

- Designed and manufactured with high-quality PVC with UV inhibitors to prevent discoloration.
- Dual strip of .5" adhesive (VPA) or .5" x .1625" magnets (VPM) for quick installation.
- Designed and manufactured with high-quality PVC with UV inhibitors to prevent discoloration.
- Heat-welded edges for added strength.

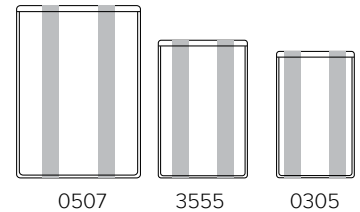

Item No.	Ref. No.	Dimensions	Finish	Pack
Adhesive Back				
1506051819	R-VPA-0305	3" x 5"	Clear	25
1502567857	R-VPA-3555	3.5" x 5.5"	Clear	25
1506977633	R-VPA-0507	5" x 7"	Clear	25
Magnetic Back				
1503715911	R-VPM-0305	3" x 5"	Clear	25
1500928463	R-VPM-3555	3.5" x 5.5"	Clear	25
1506237487	R-VPM-0507	5" x 7"	Clear	25

Adhesive Vinyl Tag Pockets

- Designed for most common, non-adhesive price tags.
- Includes thumb notch for easy insertion and removal of tags.
- Sold in packs of 25 sheets, with 10 vinyl pockets per sheet.
- Designed and manufactured with high-quality PVC with UV inhibitors to prevent discoloration.
- Heat-welded edges for added strength.

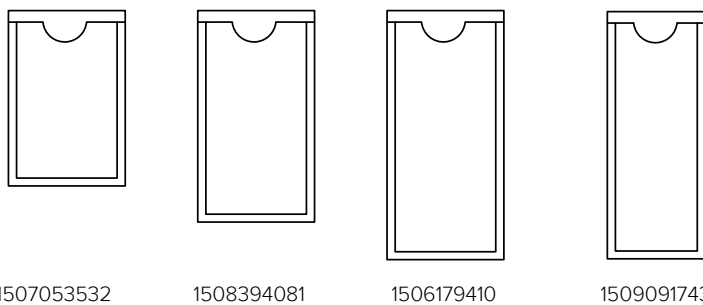

Item No.	Ref. No.	Dimensions	Finish	Pack
1507053532	R-VPT-1252	1.25" x 2"	Clear	25
1508394081	R-VPT-12525	1.25" x 2.5"	Clear	25
1506179410	R-VPT-1253	1.25" x 3"	Clear	25
1509091743	R-VPT-13	1" x 3"	Clear	25



Vinyl Pouch VP3555

- Signs and tags slide easily into open short side
- Hang with hook and loop, adhesive, or magnets
- Clear vinyl

Item No.	Ref. No.	Dimensions	Finish	Pack
3207133200	-	3" x 5"	Clear	1
3208034301	-	3.5" x 5.5"	Clear	1
3207133204	-	5" x 7"	Clear	1

Additional sizes can be made to order (minimum quantities apply).

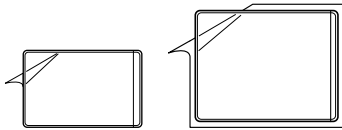

3207604900

3207604906

Vinyl Pouch with Adhesive VP3555

- Protect and display signs on flat surfaces
- Opens on short side to allow signs to easily slide into pouch
- Clear adhesive for an attractive, secure display
- Available in a variety of sizes
- Clear vinyl

Item No.	Ref. No.	Dimensions	Finish	Pack
3207604900	-	3" x 5"	Clear	1
3208497901	-	3.5" x 5.5"	Clear	1
3207604904	-	5" x 7"	Clear	1
3207604906	-	8.5" x 11"	Clear	1

Additional sizes can be made to order (minimum quantities apply).

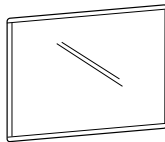

Print Protectors

- Display and protect signage behind clear window
- Ideal for flat surfaces such as walls, displays, etc.
- Compatible with Easels (below) for display on tables and counters
- Can also mount with adhesive products or any other attachment device
- Opens on short side of protector
- Clear 15 mil PVC

Item No.	Ref. No.	Dimensions	Finish	Pack
3103425901	-	4" W x 6" H	Clear	5
3103425904	-	8.5" W x 11" H	Clear	5

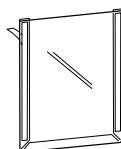

Slim-Line Pocket Sign Holder with Adhesive

- Display and protect signs with economical and clear covered-face sign holder
- Adheres to almost any clean, smooth surface with integrated foam adhesive
- Opens on short side to easily change signage
- Use vertically or horizontally
- Clear 15 mil PVC

Item No.	Ref. No.	Dimensions	Finish	Pack
3105720700	-	8.5" W x 11" H	Clear	1

Additional sizes can be made to order (minimum quantities apply).

Fold-Over Acrylic Sign Holders

- Add two-sided tape, magnets, or Velcro for wall use (not included).
- Custom sizes available. Call for details.



Item No.	Ref. No.	Dimensions	Finish	Pack
2203600214	RBS-RF1-0406	4" W x 6" H	Clear	10
2202893216	RBS-RF1-0507	5" W x 7" H	Clear	10
2207252635	RBS-RF1-8511	8.5" W x 11" H	Clear	10

Acrylic Wall-Mount Sign Holder

- Provides attractive, crystal-clear, presentation for wall-mounted signage
- Front-load signs quickly and easily
- Mounting hardware not included; mount on glass surfaces with suction cups
- Custom imprinting available (minimum order required)
- Imprint area is .125" from each side
- Clear acrylic

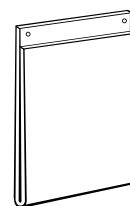

Item No.	Ref. No.	Sign Dimensions	Finish	Pack
2200872202	RBS-R1-8511	8.5" W x 11" H	Clear	1
2200872206	RBS-R1-1185	11" W x 8.5" H	Clear	1

Additional sizes can be made to order (minimum quantities apply.)

Wall-Mount Plain Sign Holder

- Use adhesive or any other attachment device to hang this sign holder
- Insert signs into short side of holder
- 2202278001 (8.5" W x 11" H) has thumb notch for easy sign removal
- Can be turned sideways for horizontal use
- Clear polystyrene



2202278001



Item No.	Ref. No.	Dimensions	Finish	Pack
2207494601	-	4" W x 6" H	Clear	1
2207933501	RBS-R1-0507	5" W x 7" H	Clear	1
2202139201	-	8" W x 10" H	Clear	1
2202278001	-	8.5" W x 11" H	Clear	1
2208752900	-	8.5" W x 2" H	Clear	1



2208752900



Wall-Mount Magnetic Sign Holder

- Comes with two magnetic strips for easy, secure attachment to filing cabinets, appliances and most other metal surfaces
- Insert signs into short side of holder
- Features a thumb notch for easy sign removal
- Clear polystyrene

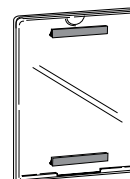

Item No.	Ref. No.	Dimensions	Finish	Pack
2202278010	-	8.5" W x 11" H	Clear	1

Additional sizes can be made to order (minimum quantities apply.)

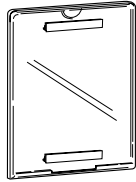

Wall-Mount Hook and Loop Sign Holder

- Hook and loop strips (included) allow attachment to any vertical surface – mounts firmly, yet it's still easy to remove signs
- Insert signs into short side of holder
- Features a thumb notch for easy sign removal
- Clear polystyrene

Item No.	Ref. No.	Dimensions	Finish	Pack
2202278005	-	8.5" W x 11" H	Clear	1

Additional sizes can be made to order (minimum quantities apply.)

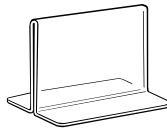

2202754105

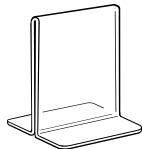

2202754102

Acrylic Bottom-Load Sign Holder

- High-quality acrylic is durable and crystal-clear
- Perfect for displaying signs on counters, shelves and tables
- Features loading slot at bottom for easy sign placement
- Polished edges for attractive presentation
- Custom imprinting available (minimum order required)
- Imprint area is .125" from each side
- Clear acrylic

Item No.	Ref. No.	Sign Dimensions	Finish	Pack
2202754101	S01-SH-CTB3	5.5" W x 7" H	Clear	1
2202754102	S01-SH-CTB7	8.5 W x 11" H	Clear	1
2202754105	S01-SH-CTB8	11" W x 8.5" H	Clear	1

Additional sizes can be made to order (minimum quantities apply.)



Side Load

Slantback Sign Holder

- Slanted back provides optimal viewing angle
- Custom imprinting available (minimum order required)
- Imprint area is .125" from each side

Side Load

- Side or bottom load signs for easy insertion and removal
- High-quality acrylic is durable and crystal-clear

Top Load

- Top-loading holder engineered for stability
- Clear polystyrene

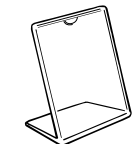

2202489800

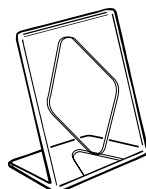

2201885101

Top Load

Item No.	Ref. No.	Sign Dimensions	Finish	Pack
Side Load				
5650186807	S01-SH-SLB1	3.5" W x 5.5" H	Clear Acrylic	10
5658206689	S01-SH-SLB2	5.5" W x 3.5" H	Clear Acrylic	10
5659318513	S01-SH-SLB4	7" W x 5.5" H	Clear Acrylic	10
2201588102	S01-SH-SLB7	8.5" W x 11" H	Clear Acrylic	1
2201588103	S01-SH-SLB8	11" W x 8.5" H	Clear Acrylic	1
2201588104	S01-SH-SLB9	11" W x 14" H	Clear Acrylic	1
Top Load				
2202489800	-	4" W x 6" H	Clear Polystyrene	1
2208088600	-	5" W x 7" H	Clear Polystyrene	1
2201885101	-	8.5" W x 11" H	Clear Polystyrene	1

Additional sizes can be made to order (minimum quantities apply.)

Acrylic Top-Load Sign Holder

- Clearly displays signs in both holder and base
- Durable high-quality acrylic construction
- Features loading slot at top for easy sign placement
- Custom 8.5" W x 1.5" H paper insert can be placed into base
- Clear acrylic

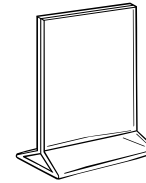

Item No.	Ref. No.	Sign Dimensions	Finish	Pack
2204737102	S01-SH-OTB7	8.5" W x 11" H	Clear	1
5650689241	S01-SH-OTB4	7" W x 5.5" H	Clear	10
5651872952	S01-SH-OTB6	11" W x 7" H	Clear	10
5652720617	S01-SH-OTB8	11" W x 8.5" H	Clear	10

Additional sizes can be made to order (minimum quantities apply.)

T-Style Sign Holder

- Display signs on any counter top, shelf or table
- Engineered for stability and crystal-clear quality display
- Custom imprinting available (minimum order required)
- Imprint area is .125" from each side
- Clear polystyrene

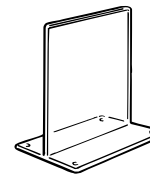

Item No.	Ref. No.	Dimensions	Finish	Pack
2208008800	-	4" W x 6" H	Clear	1
2202457201	-	8.5" W x 11" H	Clear	1

Additional standard sizes available (minimum quantity and lead time apply.)

Y-Style Sign Holder

- Lets you turn the base into selling space by having your message factory-sealed or imprinted for a long lasting, clean presentation
- Top-loading holder engineered for stability and crystal-clear quality display
- Custom paper insert can be placed into base: 1.125" H x 4" W
- Clear polystyrene

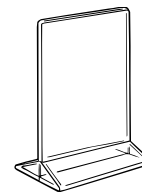

Item No.	Ref. No.	Dimensions	Finish	Pack
2201737400	-	4" W x 6" H	Clear	1

Additional standard sizes available (minimum quantity and lead time apply.)

T-Frame Sign Holder

- Non-glare style has a satin matte finish that provides an upscale look and visibility in high-glare environments
- An economical way to protect materials
- Insert signs using side or bottom of sign holder
- Clear flexible PVC

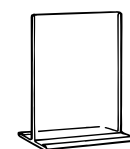

2703315400



Item No.	Ref. No.	Style	Dimensions	Pack
2702267800	-	Standard	8.5" W x 11" H	1
2703315400	-	Non-glare	8.5" W x 11" H	1

SIGN HOLDERS

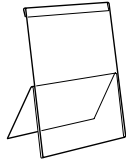

3104720500

Slim-Line Slant Sign Holder

- Economical sign holder is slanted for easy viewing
- Easily slide paper signs into holder
- Available in portrait or landscape style
- 8.5" W x 11" H or 11" W x 8.5" H
- Clear 30 mil PVC

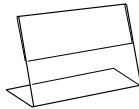

3104720545

Item No.	Ref. No.	Dimensions	Finish	Pack
3104720500	-	8.5" W x 11" H	Clear	1
3104720545	-	11" W x 8.5" H	Clear	1

Additional sizes can be made to order (minimum quantities apply.)



3103720100

Slim-Line Tent Sign Holder

- Economical tent sign holder provides double-sided viewing
- Easily slide two paper signs into holder
- Available in portrait or landscape style
- 8.5" W x 11" H or 11" W x 8.5" H
- Clear 30 mil PVC

Item No.	Ref. No.	Dimensions	Finish	Pack
3103720100	-	8.5" W x 11" H	Clear	1

Additional sizes can be made to order (minimum quantities apply.)

Easel Sign Holder with Business Card Pocket

- Place business cards right in front of promotional materials to increase response
- Top-loading holder available in two sizes to hold 4" W x 6" H or 8.5" W x 11" H signs
- Holds most standard business cards
- Base measures 2" D (4" W holder) or 3" D (8.5" W holder)
- Color imprinting available
- Pocket imprint area: 1.125" H x 3.5" W (4" W); .625" H x 3.5" W (8.5" W)
- Clear polystyrene

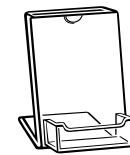

2202489801

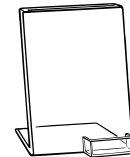

2201885104



Item No.	Ref. No.	Dimensions	Finish	Pack
2202489801	-	4" W x 6" H	Clear	1
2201885104	-	8.5" W x 11" H	Clear	1

Easel Sign Holder with Literature Pocket

- Display signs and literature in full view together
- Easel style presents a highly visible viewing angle
- Features thumb notch at top for easy sign removal
- Holds standard 8.5" W x 11" H signs
- Literature pocket holds brochures up to 4" wide
- Base measures 3" D
- Color imprinting available
- Pocket imprint area: 3.875" H x 4" W
- Clear polystyrene

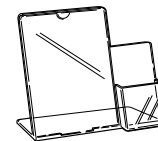

SIGN HOLDERS

Item No.	Ref. No.	Dimensions	Finish	Pack
2201885103	-	12.5" W	Clear	1

Freestanding Sign Holder with Pocket

- Combine "Take-One" service with quality P.O.P. presentation
- Easel style presents a highly visible viewing angle
- Holds standard 8.5" W x 11" H signs; top-loading
- Literature pocket holds brochures up to 4" wide
- Base measures 3.3125" D (Easel) or 3.375" D (T-style)
- 2201885102 has thumb notch for easy sign removal
- Color imprinting available
- Pocket imprint area: 3" H x 4" W (Easel); 4" H x 4" W (T-Style)
- Clear polystyrene

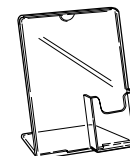

2201885102

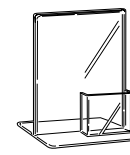

2202457202



Item No.	Ref. No.	Style	Finish	Pack
2201885102	-	Easel	Clear	1
2202457202	-	T-Style	Clear	1

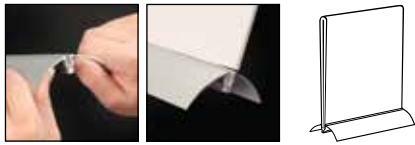

Aluminum Snap Base Sign Holder

- Versatile stand provides contemporary look and easy signage changes
- Acrylic sign holder protects signage from damage
- Accepts virtually any substrate up to .1875" thick
- Aluminum sign base / acrylic sign holder

Item No.	Ref. No.	Style	Dimensions	Pack
2160000000	-	Portrait	8.5" W x 11" H	1



Self-Sticking Cardboard Easel

- Provides sturdy, durable support for displays featuring Pop-Up® Literature Holders
- Single-wing and double-wing versions available
- Includes mounting adhesive
- 35 pt black or white SBS board
- Note: Display board not available

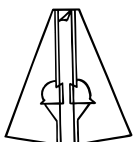

8201888503

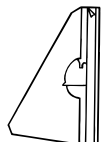

8201888501

Item No.	Ref. No.	Dimensions	Finish	Pack
Single				
8201888500	-	5" H	White	1
8201888502	-	7" H	Black	1
8201888505	-	7" H	White	1
Double				
8201888503	-	7" H	Black	1
8201888507	-	7" H	White	1
8201888504	-	12" H	Black	1
8201888508	-	12" H	White	1

Easel Back Sign Holder

- Ideal for temporary promotions or to add signage to any flat surface
- Ships flat, then folds open for quick assembly
- Clear plastic cover protects signage
- White easel back chipboard / clear 10 mil plastic cover



Item No.	Ref. No.	Dimensions	Pack
2163273503	-	8.5" W x 11" H	1
2163273506	-	11" W x 14" H	1

Additional sizes can be made to order (minimum quantities apply.)

Shopping Cart Sign Frame

- Weather-resistant sign frame mounts to shopping cart to display store messaging or advertising
- Unique design accommodates nearly any spring wire or molded cart openings
- Easy to install and change signage, no tools required
- Includes: (2) frame halves, (4) .5" screws, (2) .75" screws, (4) locking nuts and (2) cable ties for various mounting options
- Maximum space between frames .375"
- Holds 7" x 11" signs up to .08" thick
- Overall frame size is 11.5" W x 7.5" H
- Black shatter-resistant polypropylene

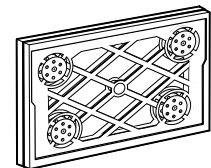

Item No.	Ref. No.	Finish	Pack
3700000000	-	Black	1

Additional colors can be made to order (minimum quantities apply.)

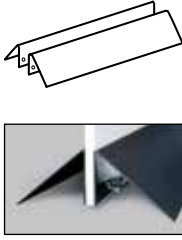

Premier™ Banner Board™ Floor Stand

- Stand displays single- or double-sided graphics (graphics not included)
- Modern frameless construction is appealing in myriad store environments
- M-shaped base fits up to 1" thick rigid substrates and up to 6' high
- Interior holes in base allow carriage bolts and wing nuts to support graphics (punch holes in graphics .25" from center or situate graphic above bolts)
- 3" H, black steel base

Item No.	Ref. No.	Dimensions	Weight	Finish	Pack
9502218824	-	24" L	10.5 lb	Black	1
9502218836	-	36" L	15.75 lb	Black	1
9502218848	-	48" L	21 lb	Black	1

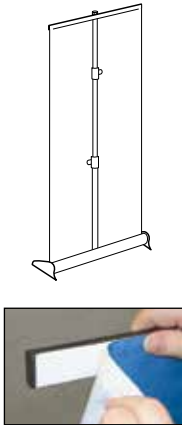
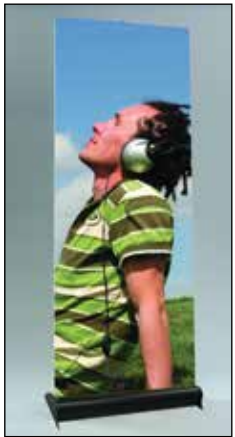

Premier™ Retractable Banner Stand

- Rolled graphic extends and retracts in seconds for easy set-up
- Telescopic pole with height adjustment up to 8' H
- Graphic extends from low-profile aluminum housing, providing easy transport
- Securely attach graphic at top of pole with integrated Hook and Loop
- Rolled graphic secures to housing with Hook and Loop – to replace, simply detach and apply new graphic
- Ideal for vinyl, fabric and other pliable materials
- 6" H x 4" W x 40" L travel bag included
- Silver aluminum pole / black aluminum housing

Item No.	Ref. No.	Dimensions	Finish	Pack
9507273600	-	36" W	Silver	1

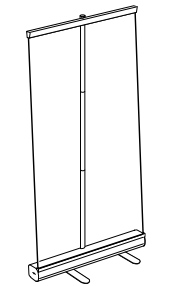

Retractable Banner Stand

- Rolled graphic extends and retracts for easy set-up
- Includes clamp top trim to finish top of graphic
- Double twist-out stabilizing feet provide a secure base
- Use with vinyl, fabric and other pliable materials
- Includes lightweight black nylon non-padded travel and storage bag
- Silver aluminum

Item No.	Ref. No.	Dimensions	Finish	Pack
9507273346	-	33.5" W x 79" H	Silver	1

Premier™ H1 Hemmed Graphic Banner Stand - Heavy-Duty

- Display hemmed banner materials including paper, vinyl and fabric
- Included .5" diameter dowel rods slide easily into holders
- Holds banners 24" W and up to 96" H; lower pole is 1" diameter; bottom holders are adjustable to match banner length
- 5 lb 12" square metal base provides stability
- Black aluminum dowels and pole / black steel base

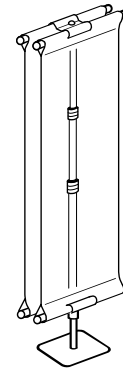

Item No.	Ref. No.	Holds Banners	Finish	Pack
9502620001	-	24" W	Black	1

Premier™ H2 Hemmed Graphic Banner Stand

- Display hemmed banner materials including paper, vinyl and fabric
- Included .5" diameter aluminum dowel rods slide easily into holders; bottom holders are adjustable to match banner length
- Easy-to-adjust aluminum telescoping pole
- Holds hemmed banners 24" W and up to 72" H
- 3.75 lb 12" square black metal base

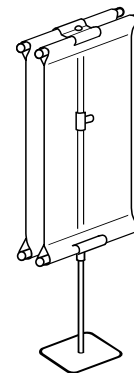

SIGN HOLDERS

Item No.	Ref. No.	Holds Banners	Finish	Pack
9503825101	-	24" W	Black	1

Premier™ MM2 SuperGrip® Banner Stand

- Telescopic pole adjusts from 36"-96" H; lower pole is 1" diameter; bottom holder adjusts to match banner length
- 7/8" W aluminum housing holds plastic banner holder insert; included end caps provide a finished look
- SuperGrip® insert snaps shut and holds all types of banner material including paper, vinyl and fabric up to .040" thick
- 5 lb 12" square base provides stability in high-traffic areas
- Black aluminum pole and housings / black steel base

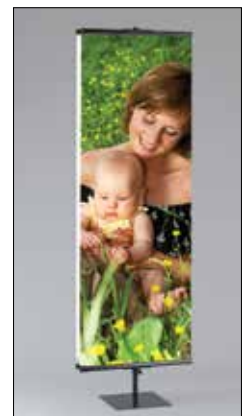
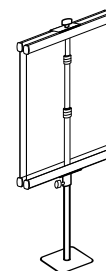

Item No.	Ref. No.	Holds Banners	Finish	Pack
9506624701	-	24" W	Black	1

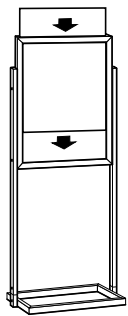

Premier™ Posterframe Floor Stand - Square Tubing

- Contemporary steel constructed stand displays two-sided 22" x 28" graphic
- Graphic inserts into top for easy sign placement and replacement
- Use with rigid material up to .25" thick
- Visible graphic area is 21" W x 27" H
- Rectangular base provides superior stability

Item No.	Ref. No.	Dimensions	Finish	Pack
9507842228	-	67" H x 25" W x 15.25" D	Black	1

SIGN HOLDERS

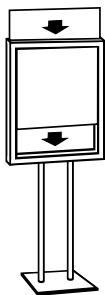

Premier™ Posterframe Floor Stand

- Highlight promotions with durable chrome or black floor stand
- Easy to assemble; durable construction
- Holds 22" W x 28" H posters up to .25" thick
- 22.5" W x 59" H overall
- Optional Chrome Wire Basket available to hold 10.5" x 14" literature
- Metal

Item No.	Ref. No.	Dimensions	Finish	Pack
Floor Stand				
9503566701	R16-VRS-G	22.5" W x 59" H	Chrome	1
9503566702	-	22.5" W x 59" H	Black	1
Wire Basket				
9502275300	R-WSB21	18" W x 11" D x 8" H	Chrome	1

Premier™ Metal Sign Frame Display Stand

- Display durable, attention-getting metal sign frames
- Fixed pole is 36" H
- Frames quickly and easily mount to pole with integrated flat head screw
- Two sign frame sizes available: 8.5" x 11" and 11" x 14" (7.375" W x 9.875" H and 9.875" W x 12.875" H visible graphic area)
- Frames accept rigid material up to .125" thick
- 5 lb 12" square metal base provides stability
- Black aluminum pole and frames / black steel base

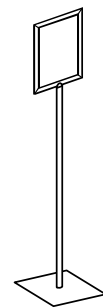

Item No.	Ref. No.	Frame Dim.	Finish	Pack
9507773801	-	11" H x 8.5" W	Black	1
9507773802	-	14" H x 11" W	Black	1

SIGN HOLDERS

Premier™ Covered-Face Sign Display Stand

- Crystal-clear covered-face sign holder attractively displays graphics
- Telescopic pole adjusts from 34" to 64" H; lower pole is .75" diameter
- Sign holder securely mounts to pole with integrated twist-on lock
- Clear acrylic sign holder accepts 8.5" W x 11" H graphics
- 5 lb 12" square metal base provides stability
- Black aluminum pole / clear acrylic sign holder /black steel base

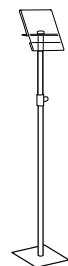

Item No.	Ref. No.	Frame Dim.	Finish	Pack
9507438201	-	11" H x 8.5" W	Black	1



Square



Round

Indoor/Outdoor A-Frame Sign Holder

- Use with temporary promotions or for signage that needs to move on a regular basis
- Suitable for outdoor use; unit folds for easy transport
- Quality anodized aluminum construction for attractive display and long life
- Mitered frame opens to accept graphics up to .0625" thick and clamps shut with spring tension for a secure hold
- Available to display 22" W x 28" H or 24" W x 36" H graphics
- Silver aluminum

Item No.	Ref. No.	Dimensions	Style	Pack
9509776902	R-FAF-2228B	22" W x 28" H	Round	1
9508768503	R-FAF-2436B	24" W x 36" H	Square	1

Premier™ Adjustable Display Easel

- All-purpose display easel
- Telescopic legs extend easel height from 34” to 66” quickly and easily with twist adjustment
- Display brackets hold signs and adjust to the ideal sign height and thickness
- Easel folds to 35.5” H for easy transport; 30”H from display brackets to top
- Non-skid rubber feet
- Silver aluminum



Item No.	Ref. No.	Dimensions	Finish	Pack
9507335002	-	34"- 66" H	Silver	1

Portable A-Frame Sign Holder

- Durable, portable, double-sided A-frame ideal for use with temporary promotions or for signage that needs to move on a regular basis
- Suitable for outdoor use; unit folds for easy and cost-effective transport
- Quality aluminum frames, legs and stays provide attractive display and long life
- Available to display 22” W x 28” H or 24” W x 36” H graphics
- Accepts rigid graphics up to .25” thick through top entry slot
- 5.5 lb, 2.5” W x 2.5” D x 44.5” H closed
- Satin silver finish aluminum

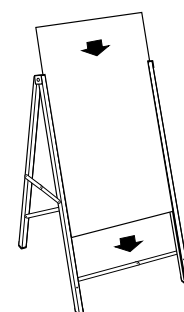

Item No.	Ref. No.	Dimensions	Finish	Pack
9501640902	-	24" W x 36" H	Silver	1

SIGN HOLDERS



PATENTED

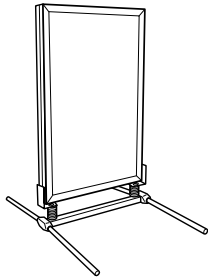

Windmaster® Sign Frame with Fixed Base

- Superior durability and wind resistance for outdoor signs
- Springs flex to keep signs standing even in strong wind gusts
- Ideal for temporary promotions or signs that need to move regularly
- Tool-free assembly; leg brackets easily snap into place
- Front-loading mitered sign frame rails snap open for easy sign placement
- Holds signs 28" W x 44" H, up to .030" thick; Rails are 1.75" W (visible area 25.4375" W x 41.4375" H)
- Durable and lightweight 4 mil white fluted polypropylene backer included
- Black aluminum frame / black rust-resistant steel base

Item No.	Ref. No.	Dimensions	Finish	Pack
9504360153	-	28" W x 44" H	Black	1

Additional sizes and colors can be made to order (minimum quantities apply.)

Windmaster® Sign Frame with Rolling Base



PATENTED

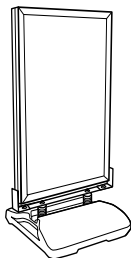

9504360151

- Pairs easy mobility with superior durability and wind resistance for outdoor signs
- Springs flex to keep signs standing even in strong wind gusts
- Rolling base makes it simple to relocate signs, built in wheels engage when sign frame is tilted and disengage when sign frame is in upright position
- Base can be weighted with liquid or sand for additional stability
- Front-loading mitered sign frame rails snap open for easy sign placement
- Tool-free assembly; screw knobs hold frame securely to base

9504360151 double-sided framed style:

- Holds signs 28" W x 44" H, up to .030" thick; Rails are 1.75" W (visible area 25.4375" W x 41.4375" H)
- Durable and lightweight 4 mil white fluted polypropylene backer included
- Black mitered aluminum frame rails / gray plastic base

9504360161 double-sided slim framed style:

- Eye-catching tall, narrow frame captures customer attention (70.5" overall height)
- Holds signs 18" W x 56" H, up to .060" thick; Rails are 1.75" W (visible area 16.25" W x 55" H)
- Durable and lightweight 10 mil white fluted polypropylene backer included
- Black aluminum frame / black plastic base

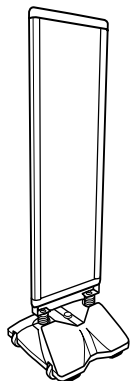

9504360161

Item No.	Ref. No.	Dimensions	Finish	Pack
9504360152	-	28" W x 44" H	Silver	1
9504360161	-	18" W x 56" H	Silver	1

Additional sizes and colors can be made to order (minimum quantities apply.)

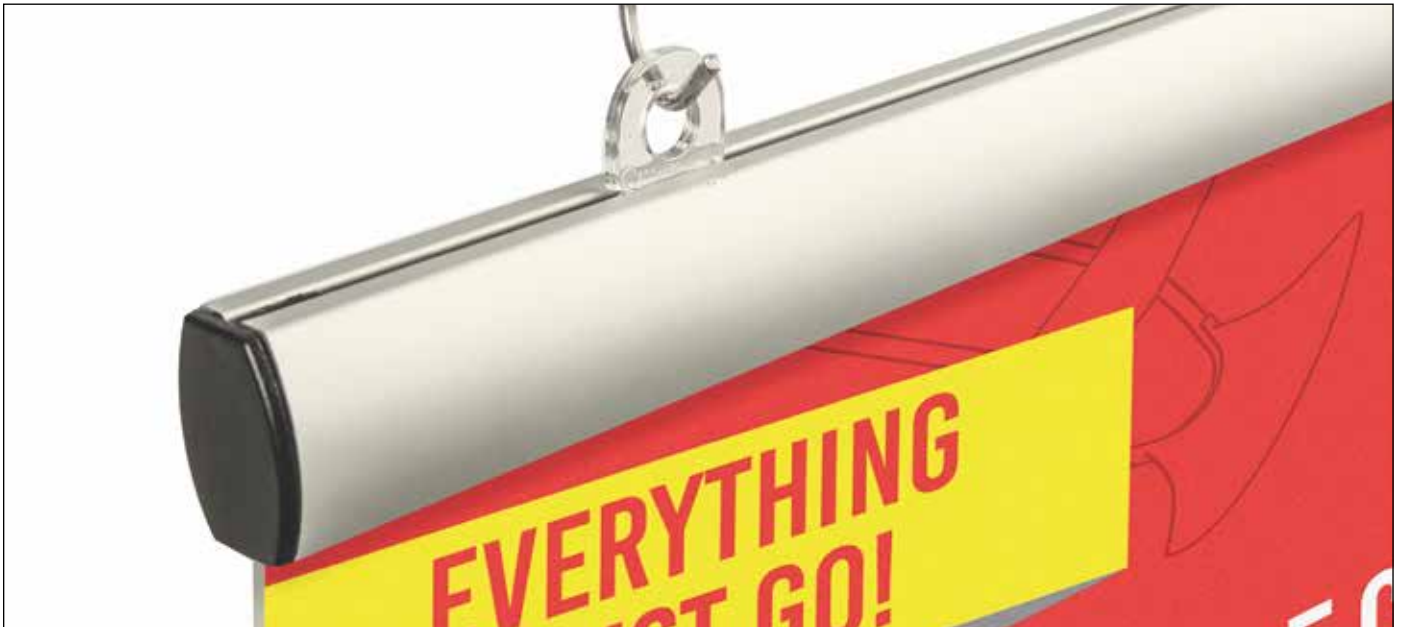

Elite™ Aluminum Banner Hanger System

Ceiling Displays

Maximize impact with minimal use of space

Judging by the placement of enticing fresh displays at the entrance of nearly every grocery store, retailers are clearly aware that the fresh area is one of the most important sections of a store's layout. But, what makes this area so appealing to customers?

While location at the store entrance seems to be the most important factor, presentation follows a close second. Here are six factors to keep in mind when setting or resetting your fresh area:

- ◆ Keep displays looking full
- ◆ Maintain a flexible layout
- ◆ Merchandise vertically
- ◆ Refrigerate appropriately
- ◆ Use ample lighting
- ◆ Don't forget signage

This guide includes a wide variety of products to help you maximize impact with minimal use of space.



Spiral Sign Board System



Mercury™ Banner Hanger System



C-Link Banner Hanger



Create a custom banner system from a wide selection of banners, clips, hooks and other accessories

Create A Banner System

Create a custom banner system by selecting the ceiling display components that fit your ceiling display needs for maximize visual impact.

Choose your components

- 1 Select a top Banner Hanger
- 2 Select End Caps, if applicable
- 3 Select a bottom Banner Hanger/Stabilizer, if applicable
- 4 Select a Hanger Clip, if applicable
- 5 Select a Hanging Accessory
- 6 Select a Ceiling Clip

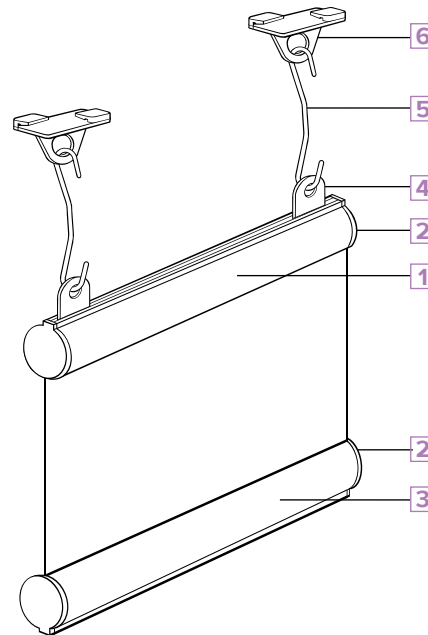

Paper Thickness Chart

Inches	Millimeters	Points	Everyday Object
0.001	.025	1	newspaper page
0.01	.25	10	business card
0.04	1	40	Blu-Ray disk
0.06	1.5	60	penny
0.08	2	80	house key
0.125	3.125	125	pizza box
0.25	6.25	250	no.2 pencil

siffron's products are intended only for indoor use at ambient temperatures. We do not recommend outdoor use of our products or use in high temperature environments, such as exterior windows exposed to sunlight and areas with intense electrical lighting. If you have any questions concerning the use of siffron's products outdoors, or at temperatures other than ambient, please call us. Maximum recommended weight for all ceiling banner systems and accessories is 3 lb per ceiling attachment.

Elite™ Elliptical Aluminum Banner Kit

- Ready-Made Banner Kits include everything you need to quickly hang your banner
- An upscale look, ideal for nearly any size banners, including large signs and graphics
- Plastic Mercury™ banner holder inserts into attractive aluminum housing
- SuperGrip® technology holds paper, vinyl, fabric and most plastic banners up to .040" thick
- Kit includes: two silver aluminum Elite™ Banner Hangers with Mercury™ Insert, four black End Caps and two clear Hanger Clips, two clear 12" L Plastic Double C-Hooks, and two clear Sure-Twist® Ceiling Loops

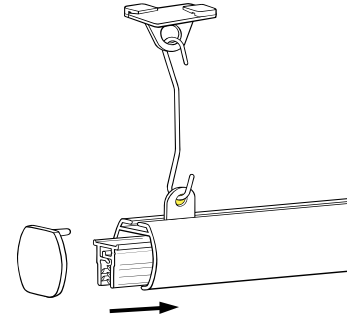

Item No.	Ref. No.	Dimensions	Finish	Pack
6113245301	-	22" L	Silver	1 Kit
6113245302	-	36" L	Silver	1 Kit
6113245303	-	48" L	Silver	1 Kit

Mercury™ Banner Kit

- Ready-Made Banner Kits include everything you need to quickly hang your banner
- SuperGrip® brand technology provides secure hold in attractive square profile
- Holds paper, vinyl, fabric or most plastic banners up to .040" thick
- Kit includes: two clear Mercury™ Banner Hangers, two natural Banner Hanger Clips, and two white Universal Plastic Ceiling Hooks with 8' L white barbed cord

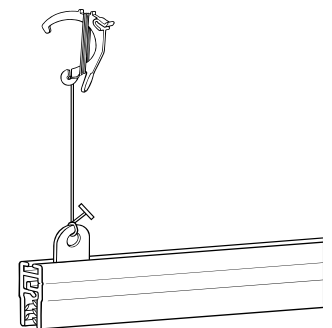
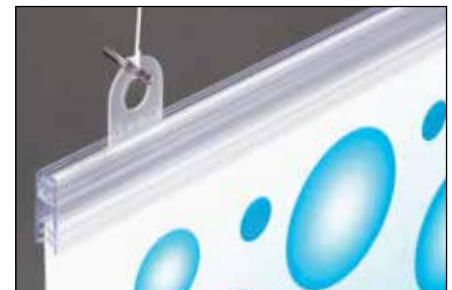

Item No.	Ref. No.	Dimensions	Finish	Pack
6110624501	-	22" L	Clear	1 Kit
6110624502	-	36" L	Clear	1 Kit
6110624503	-	48" L	Clear	1 Kit

* Many factors can impact a banner hanger's holding performance, including material type, thickness, size and weight, as well as ambient temperature where the banner is being hung; we highly recommend you test your exact banner with your selected banner hanger.

Elite™ Aluminum Banner Hanging System

- An upscale look, ideal for nearly any size banners, including large signs and graphics.
- System includes aluminum housing, inserts and accessories (sold separately)
- Easy assembly

Banner Housing

- Housing available in Elliptical styles
- Accepts .1875" thick foamboard or .3875" rod
- Silver aluminum housing

Mercury™ Insert

- Snap-shut, hinged insert holds banners securely using SuperGrip® technology
- Clear PVC

Graphic Fastener

- Insert graphic fasteners into pre-punched banner holes and slide graphic into the Elite™ housing
- Natural nylon

Hanger Clip

- Slides into track of housing to hang banner system
- Closed loop compatible with S-Hooks, C-Hooks, cord or other hanging accessories
- Clear plastic

End Cap

- Provides finished appearance to banner system
- Available for all Elite™ profiles
- Black plastic

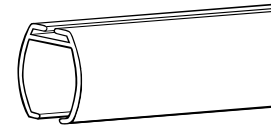

Elliptical



Mercury™ Insert

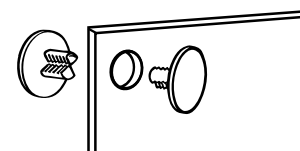

Graphic Fastener



Hanger Clip



Elliptical End Cap

Item No.	Ref. No.	Style	Dim.	Finish	Pack
6114791411	-	Elliptical Housing	24" L	Silver	1
6114791405	-	Elliptical Housing	36" L	Silver	1
6114791406	-	Elliptical Housing	48" L	Silver	1
6110258405	-	Mercury™ Insert	24" L	Clear	1
6110258402	-	Mercury™ Insert	36" L	Clear	1
6110258403	-	Mercury™ Insert	48" L	Clear	1
8506232201	-	Graphic Fastener	.40" Head	Natural	2
6105973401	-	Hanger Clip	n/a	Clear	1
6113768001	-	Elliptical End Cap	n/a	Black	1

* Many factors can impact a banner hanger's holding performance, including material type, thickness, size and weight, as well as ambient temperature where the banner is being hung; we highly recommend you test your exact banner with your selected banner hanger.

Elite™ Aluminum Poster Rails

- Chic aluminum rails complement fashionable store environments
- Durable metal construction provides a long-lasting sign solution
- Ideal for displaying posters in store windows and from high ceilings
- Combine top and bottom rail to display signage from 22" to 72" wide
- Clamp-shut rail contains a rubber strip for a secure hold
- Black end caps provide a finished look
- Includes top and bottom rail, hanging clips, and end caps
- Silver anodized aluminum

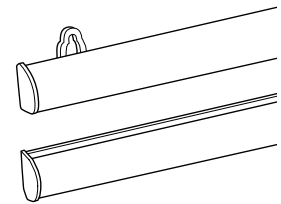
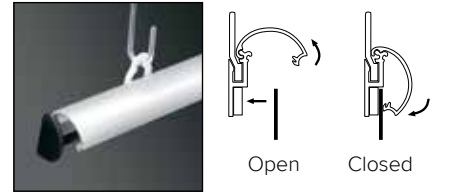

Item No.	Ref. No.	Dimensions	Finish	Pack
3707032501	-	22" L	Silver	1
3707032502	-	24" L	Silver	1
3707032503	-	28" L	Silver	1
3707032505	-	36" L	Silver	1
3707032506	-	48" L	Silver	1
3707032507	-	60" L	Silver	1
3707032508	-	72" L	Silver	1

Additional lengths can be made to order (minimum quantities apply.)

Space Commander® Banner Hanger with Track

- Snap-shut, 1" diameter hinged tube holds banners securely using SuperGrip® brand technology
- Can also be used as bottom edge stabilizer
- Holds paper, vinyl, fabric and most plastic banner materials up to .125" thick
- Banner Hanger Clip slides into top track to accept hanging accessories
- Available end caps provide finished appearance
- Joiner available to connect multiple banner hangers
- White, black, silver or clear PVC; polypropylene end caps

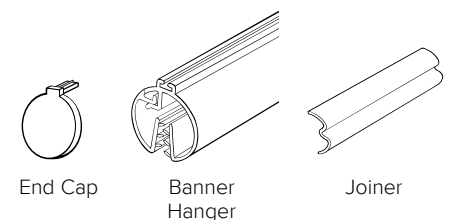

Item No.	Ref. No.	Style	Dim.	Finish	Pack
6115686929	-	Banner Hanger	22" L	Clear	1
6115686900	-	Banner Hanger	24" L	Black	1
6115686926	-	Banner Hanger	24" L	Clear	1
6115686903	-	Banner Hanger	36" L	White	1
6115686904	-	Banner Hanger	36" L	Black	1
6115686911	-	Banner Hanger	36" L	Silver	1
6115686909	-	Banner Hanger	36" L	Clear	1
6115686905	-	Banner Hanger	48" L	White	1
6115686906	-	Banner Hanger	48" L	Black	1
6115686912	-	Banner Hanger	48" L	Silver	1
6115686919	-	Banner Hanger	48" L	Clear	1
6110612101	-	End Cap	n/a	White	1
6110612102	-	End Cap	n/a	Black	1
6110612105	-	End Cap	n/a	Silver	1

Additional lengths and colors can be made to order (minimum quantities apply.)

* Many factors can impact a banner hanger's holding performance, including material type, thickness, size and weight, as well as ambient temperature where the banner is being hung; we highly recommend you test your exact banner with your selected banner hanger.

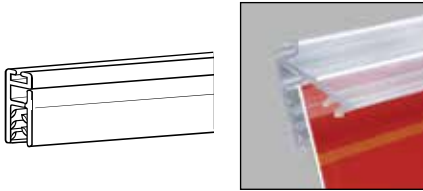
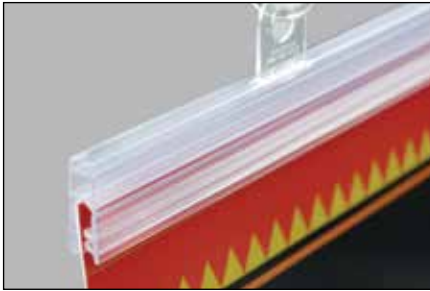

Mercury™ Fast Load™ Banner Hanging System

- Fast Load™ design features a closed, hinged sign channel to make inserting and securing signage quick and simple
- Reliable SuperGrip® technology secures banners in reverse-angle grippers
- Snaps shut to hold banners securely
- Holds paper, vinyl, fabric and most plastic banners up to .040" thick
- Banner Hanger Clip slides into top track to accept banner hanging accessories
- Shown with Plastic Double C-Hook
- Can also be used as a stabilizer
- Clear PVC

Item No.	Ref. No.	Dimensions	Finish	Pack
6118557403	-	24" L	Clear	1
6118557405	-	36" L	Clear	1
6118557407	-	48" L	Clear	1

Additional lengths and colors can be made to order (minimum quantities apply.)

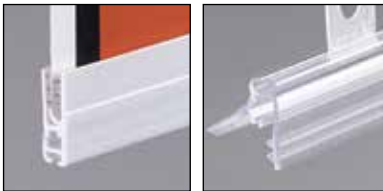

Mercury™ Banner Hanging System

- Reliable SuperGrip® holding power in a square profile
- Snaps shut to hold banners securely
- Holds paper, vinyl, fabric and most plastic banners up to .040" thick
- Banner Hanger Clip slides into top track to accept hanging accessories
- Shown with Plastic Double C-Hook
- Can also be used as a stabilizer
- Clear, black or white PVC



Banner Hanger



Banner Hanger Clip

Item No.	Ref. No.	Style	Dim.	Finish	Pack
6112562501	RFG2-BH22	Banner Hanger	22" L	Clear	1
6112562509	RFG2-BH24	Banner Hanger	24" L	Clear	1
6112562507	-	Banner Hanger	24" L	Black	1
6112562502	RFG2-BH36	Banner Hanger	36" L	Clear	1
6112562505	-	Banner Hanger	36" L	Black	1
6112562503	RFG2-BH48	Banner Hanger	48" L	Clear	1
6112562506	-	Banner Hanger	48" L	Black	1
6103838804	-	Banner Hanger Clip	n/a	Clear	1

Additional lengths and colors can be made to order (minimum quantities apply.)

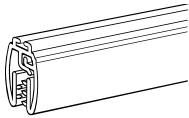

Banner Hanger



Banner Hanger Clip

Mercury™ Designer Series Banner Hanger with Track

- Elliptical style provides upscale, designer look
- Snap-shut, hinged holder holds banners securely using SuperGrip® technology
- Holds paper, vinyl, fabric and most plastic banners up to .060" thick
- Banner Hanger Clip slides into top track to accept hanging accessories
- Shown with Plastic Double C-Hook
- Clear, black or white PVC

Item No.	Ref. No.	Style	Dim.	Finish	Pack
6116252501	-	Banner Hanger	22" L	Clear	1
6116252505	-	Banner Hanger	24" L	Clear	1
6116252506	-	Banner Hanger	24" L	Black	1
6116252509	-	Banner Hanger	36" L	Clear	1
6116252510	-	Banner Hanger	36" L	Black	1
6116252511	-	Banner Hanger	36" L	White	1
6116252513	-	Banner Hanger	48" L	Clear	1
6116252514	-	Banner Hanger	48" L	Black	1
6103838804	-	Banner Hanger Clip	n/a	Clear	1

Additional lengths and colors can be made to order (minimum quantities apply.)

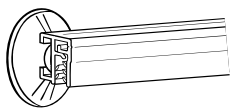

Mercury™ Banner Hanger with Suction Cups

- Ideal for promotions, product or pricing messages
- Integrated suction cup track with 1.75" O.D. suction cups affix securely to glass surfaces
- SuperGrip® brand technology with snap-shut hinged design holds paper, vinyl and fabric signage up to .040" thick
- Clear PVC

Item No.	Ref. No.	Dim.	Suction Cup	Pack
6110906600	-	22" L	2	1
6110906601	-	36" L	3	1

Additional lengths and colors can be made to order (minimum quantities apply.)

Note: Should not be used where ambient temperature exceeds 140°F.

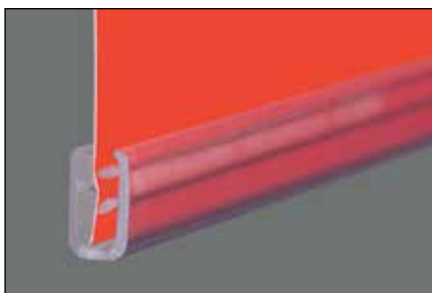

SuperGrip® Budget Banner Hanger/Stabilizer

- Keep banners straight and secure
- Accepts banners .015" to .080" thick
- Clear or black PVC

Item No.	Ref. No.	Dimensions	Finish	Pack
6112125609	-	48" L	Clear	1

Additional lengths and colors can be made to order (minimum quantities apply.)

* Many factors can impact a banner hanger's holding performance, including material type, thickness, size and weight, as well as ambient temperature where the banner is being hung; we highly recommend you test your exact banner with your selected banner hanger.



SuperGrip® Atlas Banner Hanger

- Extra holding power for longer, heavier paper banners plastic signs and coated materials
- Two capacities available: holds materials .015" to .080" thick, or .125" to .1875" thick
- Shown with Banner Hanger Clip and Plastic Double C-Hook
- Clear PVC

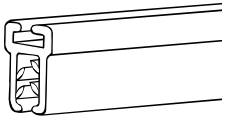

Banner Hanger



Banner Hanger Clip

Item No.	Style	Capacity	Dim.	Finish	Pack
6118056602	Banner Hanger	.080"	36" L	Clear	1
6118056603	Banner Hanger	.080"	48" L	Clear	1
6113327103	Banner Hanger	.125"-1875"	48" L	Clear	1
6103838804	Banner Hanger Clip	n/a	n/a		1

Additional lengths and colors can be made to order (minimum quantities apply.)



SuperGrip® Simplicity Banner Hanger

- Holding power for longer, heavier paper banners, plastic signs and coated materials
- Holds banners .015" to .080" thick
- Features integrated hanging holes
- Shown with Plastic Double C-Hook
- Clear PVC

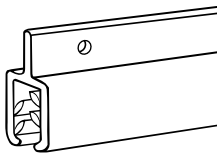

Item No.	Ref. No.	Capacity	Dim.	Finish	Pack
6112213901	-	.080"	22" L	Clear	1
6112213927	-	.080"	24" L	Clear	1
6112213902	-	.080"	36" L	Clear	1
6112213903	-	.080"	48" L	Clear	1

Additional lengths and colors can be made to order (minimum quantities apply.)



Budget Banner Hanger/Stabilizer

- Keep banners straight and secure
- Stabilizer slides directly onto bottom edge of banner
- Works with any banner hanging system
- Holds up to .125" paper banners
- Clear PVC

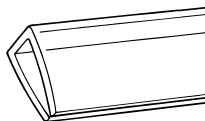

Item No.	Ref. No.	Dimensions	Finish	Pack
6102095410	-	24" L	Clear	1
6102095418	-	36" L	Clear	1
6102095423	-	48" L	Clear	1

Additional lengths and colors can be made to order (minimum quantities apply.)



Spiral Sign Board System

- Display sign boards from most standard retail gondolas or ceilings
- Mount to gondolas with brackets (below) or hang from ceiling with ceiling display accessories
- Double-sided board holds signs spiral bound pads
- Holds 7.875" H signs in top channel, 11.125" H spiral pads in bottom channel
- Spiral pads feature a variety of printed characters and messages
- White polystyrene sign board
- Polystyrene spiral pads

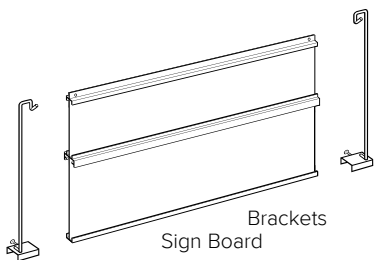

Dollar Pad Contains:
0, 1, 2, 3, 4, 5, 6, 7, 8, 9, \$,
Blank (Black type)



Cent Pad Contains:
0, 1, 2, 3, 4, 5, 6, 7, 8, 9, ¢,
Blank (Black type)



Reading Pad Contains:
% off, From, For, Reg, Now, And
Up, After Rebate, Each, To,
Decimal, Arrow, Blank (Black type)

Item No.	Ref. No.	Style	Dimensions	Pack
3800152600	R-SSB-20X34	Sign Board	20.375" H x 34" W	1
3803781862	R72-23SSBH-W	Brackets	22" H	2
3800301000	R-SSP-11D	Dollar Pad	11.125" H x 5.30" W	1
3800301100	R-SSP-11C	Cent Pad	11.125" H x 3" W	1
3800301200	R-SSP-11R	Reading Pad	11.125" H x 3" W	1

Additional sizes and colors can be made to order (minimum quantities apply.)

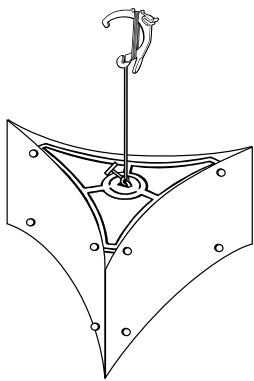

With Hook

Triad™ Mobile Kits TR-94

- A sturdy approach to creating 3-sided mobile displays
- Holds panels from 10" to 24" or 15" to 40" wide
- Can be used with 1.5" O.D. Display Poles to create pole displays
- Natural polypropylene

6202153201 kit includes:

- 1 Universal Plastic Ceiling Hook, 4' white cord
- 2 small Triad™ formers

6202153203 kit includes:

- 1 Sure-Twist® Ceiling Clip, 4' white cord
- 2 small Triad™ formers

6207963901 kit includes:

- 1 Universal Plastic Ceiling Hook, 4' white cord
- 2 large Triad™ formers

6207963904 kit includes:

- 1 Sure-Twist® Ceiling Clip, 4' white cord
- 2 large Triad™ formers

Item No.	Ref. No.	Panel Size	Style	Pack
6202153201	RTP-SM	10-24" L	w/ Hook	1 Kit
6202153203	-	10-24" L	w/ Sure-Twist®	1 Kit
6207963901	RTP-LG	15-40" L	w/ Hook	1 Kit
6207963904	-	15-40" L	w/ Sure-Twist®	1 Kit



Four.front™ Mobile Kits FF-96

- Create 4-sided mobiles for high impact displays
- Displays panels from 12" to 24" wide
- Can be used with 1.5" and 1.75" O.D. Display Poles to create pole displays
- Natural polypropylene

Kit includes:

- 1 Universal Plastic Ceiling Hook, 4' white cord
- 2 Four•front™ formers

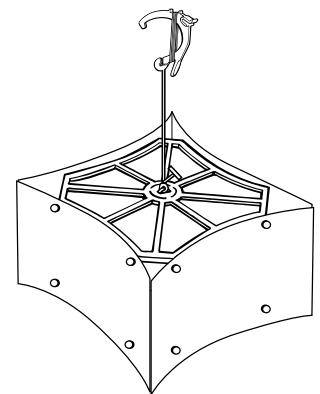

With Hook

Item No.	Ref. No.	Style	Finish	Pack
6208025401	-	w/ Hook	Natural	1 Kit



U-Hook Banner Hanger

- U-Hook securely displays thicker sign materials
- Display signage materials up to .75" thick, including foam board
- Attach sign panels back-to-back
- Use with .5" or .75" Aluminum Adjust-A-Lok (not included, see below)
- Fits .25" diameter holes
- Galvanized steel

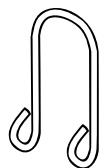

U-Hook

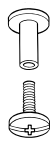

Adjust-A-Lok

Item No.	Ref. No.	Style	Dimensions	Pack
6402196100	-	U-Hook	2" L	1
8502034500	-	Adjust-A-Lok	.5" L	1
8500600401	-	Adjust-A-Lok	.75" L	1

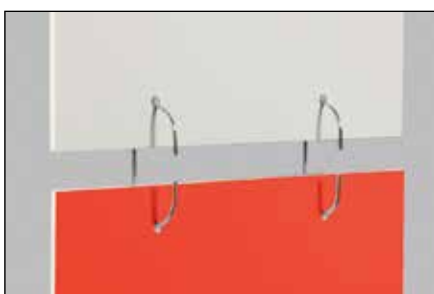

C-Link Banner Hanger

- Economically link hanging banners to create eye-catching multi-banner displays
- Available in two sizes: 1.5" L or 3" L
- 1.5" L link has .46875" opening
- 3" L link has .625" opening
- .093" diameter galvanized steel
- Packaged: 100/bag

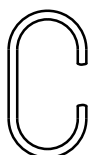

Item No.	Ref. No.	Dim.	Opening Dim.	Pack
6402065000	-	1.5" L	.46875"	100
6402065001	-	3" L	.625"	100

Additional sizes can be made to order (minimum quantities apply.)



Banner Hanger Clip

- Slides into track of Space Commander®, Mercury™ and Mercury™ Designer Series Banner Hangers, and all Atlas Banner Hangers
- 3/16" diameter hole
- Shown with the Plastic Double C-Hook and Mercury™ Designer Series Banner Hanger
- Natural, white or black polypropylene; clear polycarbonate



Item No.	Ref. No.	Finish	Pack
6103838804	-	Clear	1

Additional colors can be made to order (minimum quantities apply.)

Sure-Twist® Ceiling Clip

- Locks into place with an audible “click”
- Patented twist and lock design easily installs onto standard 1” ceiling grid
- Barbed clear monofilament or white cord available in 4’, 6’ and 8’ lengths
- Compatible with Installation Poles
- White ABS
- Packaged: 100/bag



Item No.	Ref. No.	Dim.	Cord Color	Pack
6406351801	-	4' L	Clear	100
6408153601	-	4' L	White	100
6406351802	-	6' L	Clear	100
6408153602	R16-CC007-6	6' L	White	100
6406351803	-	8' L	Clear	100
6408153603	-	8' L	White	100

Additional cord lengths can be made to order (minimum quantities apply.)

DO NOT HANG BANNERS DIRECTLY FROM BARBS — CORD MUST BE TIED TO ITS ATTACHMENT.

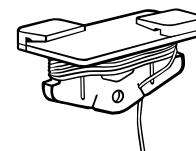

Eagle™ Ceiling Clip

- Snap hinge locks securely to standard 1” metal ceiling grids
- Twists off for easy removal
- Barbed clear monofilament or white cord is available in 4’, 6’ and 8’ lengths
- Extends 1.5” from ceiling
- White polypropylene
- Packaged: 200/bag



Item No.	Ref. No.	Dim.	Cord Color	Pack
6402557001	-	4' L	Clear	200
6401693802	-	4' L	White	200
6401693803	-	6' L	White	200
6402557003	-	8' L	Clear	200
6401693804	-	8' L	White	200

DO NOT HANG BANNERS DIRECTLY FROM BARBS — CORD MUST BE TIED TO ITS ATTACHMENT.



Universal Plastic Ceiling Hook

- Clip or hang from ceilings, poles or other fixtures
- Barbed clear monofilament or white cord available in 4’, 6’ and 8’ lengths
- White multi-split cord available in 6’ L (branches are 2’ L, cord is 4’ L)
- White or clear ABS
- Packaged: 200/bag

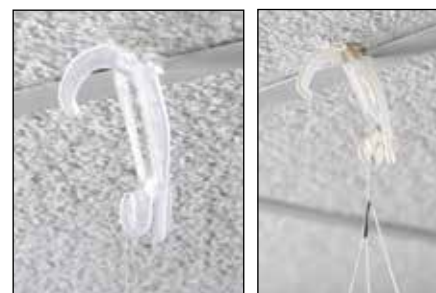

Item No.	Ref. No.	Dim.	Clip Color	Cord Color	Pack
Single Cord – 1 Branch					
6401988207	-	4' L	White	Clear	200
6401988201	-	4' L	White	White	200
6401988204	-	6' L	White	Clear	200
6401988202	RPHC-6	6' L	White	White	200
6401988208	-	8' L	White	Clear	200
6401988203	-	8' L	White	White	200
Multi-Split Cord – 3 Branches					
6402440301	-	6' L	White	White	200

DO NOT HANG BANNERS DIRECTLY FROM BARBS — CORD MUST BE TIED TO ITS ATTACHMENT.



Single Cord



Multi-Split Cord

WARNING:
Maximum recommended weight for all ceiling banner systems and accessories is 3 lb per ceiling attachment.

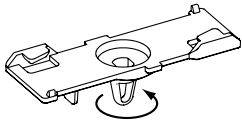

Swivel Ceiling Grid Clip

- Clip swivels to display signs in any position
- Fits most standard 1" ceiling grid
- Accommodates cord, chain and hooks
- Clear polycarbonate

Item No.	Ref. No.	Dimensions	Finish	Pack
6404453501	R-SWCC-3	3.25" L	Clear	1

Additional colors can be made to order (minimum quantities apply.)



Metal Sure-Twist® Ceiling Loop

- Metal twist-and-lock clip securely holds ceiling displays
- Features Sure-Twist® audible “click” that ensures the clip is locked on the grid
- Fits most standard 1" ceiling grid
- .4375" diameter loop accommodates hooks and cord
- White metal

Item No.	Ref. No.	Dimensions	Finish	Pack
6401046701	R16-CC011	1.5" L	White	1

Additional colors can be made to order (minimum quantities apply.)

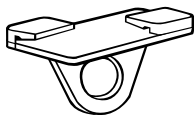

Sure-Twist® Ceiling Loop

- Sure-Twist® “click” will let you know when the Ceiling Loop is secure
- Twist and lock design attaches to standard 1" ceiling grid
- Features .850" diameter loop
- White or clear ABS
- Packaged: 50/bag

Item No.	Ref. No.	Dimensions	Finish	Pack
6406643201	R16-CC001	2.25" L	White	50
6406643203	-	2.25" L	Clear	50

Additional colors can be made to order (minimum quantities apply.)

Ceiling Grid Clip

- Accommodates S-Hooks and Double C-Hooks
- Clips securely to standard 1" ceiling grids
- .125" hole accepts most hooks
- Clear butyrate



Item No.	Ref. No.	Dimensions	Finish	Pack
6407850801	RKCH-7/8	.625" W	Clear	1

Additional colors can be made to order (minimum quantities apply.)

Swivel Loop Ceiling Clip

- Easily snaps onto standard 1" ceiling grids
- .1875" loop allows for easy hook attachment
- Loop rotates to display signs in any position
- Natural or white polypropylene



Item No.	Ref. No.	Dimensions	Finish	Pack
6402289600	-	.75" W x 1" L	Natural	1
6402289601	-	.75" W x 1" L	White	1

Additional colors can be made to order (minimum quantities apply.)

Ceiling Grid Loop 7103

- Easy-to-use design attaches to one side of ceiling grid
- .1875" loop allows for easy hook attachment
- Natural nylon

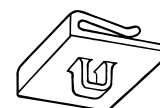

Item No.	Ref. No.	Dimensions	Finish	Pack
6408092800	-	.75" W x .75" L	Natural	1

Additional colors can be made to order (minimum quantities apply.)



Ceiling Grid Hook 2277

- Clips easily and securely to one side of ceiling grid
- Open hook permits hanging closed loops or chains, as well as Double C-Hooks or S-Hooks
- White acetal
- Packaged: 100/bag

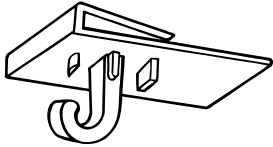

Item No.	Ref. No.	Dimensions	Finish	Pack
6408135900	-	.75" W x 1.125" L	White	100



Sure-Twist® Ceiling Hook

- Patented twist-and-lock design features
- Sure-Twist® audible “click” that ensures the clip is locked on the grid
- Fits most standard 1” ceiling grid
- Hook accommodates cord, chain, and hooks
- Clear or white ABS

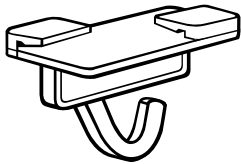

Item No.	Ref. No.	Dimensions	Finish	Pack
6407743201	-	2.25" L	White	1
6407743202	-	2.25" L	Clear	1

Additional colors can be made to order (minimum quantities apply.)

WARNING: Maximum recommended weight for all ceiling banner systems and accessories is 3 lb per ceiling attachment.

Aluminum Ceiling Hook

- Metal clips securely hold ceiling displays
- Available in one-piece and two-piece styles
- Two-piece style has Left and Right pieces – use a Left and Right to create an open loop hook and two Lefts or two Rights to create a closed loop hook
- Fits most standard 1" ceiling grid
- Hook accommodates cord, chain, and hooks
- White metal

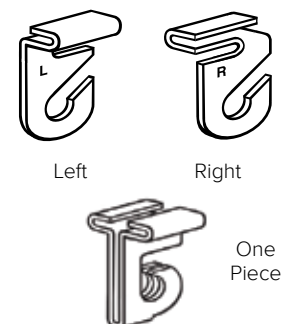

Item No.	Ref. No.	Dimensions	Finish	Pack
6405425800	-	Left	White	1
6405425801	-	Right	White	1
6401420300		One-Piece	White	1

Additional colors can be made to order (minimum quantities apply.)

Snap 'n' Hang™ Ceiling Loop Clip

- Snaps onto acoustical ceiling T-bar grid
- Ideal for hanging items utilizing “C” style or hangers or S-hook
- Loop style is in fixed position and does not rotate
- Each clip can hold up to 10 pounds of weight

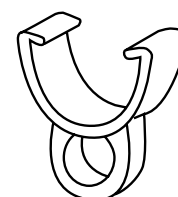

Item No.	Ref. No.	Dimensions	Finish	Pack
6108567638	RSH100	1.0625"W x .5" D x 1.0625"H	White	100



Adhesive Hanging Loop

- Simple peel-and-stick application
- Permanent adhesive back attaches loop to most surfaces
- .1875" loop allows for easy hook attachment
- Shown with Plastic Double C-Hook
- White polystyrene

Item No.	Ref. No.	Dimensions	Finish	Pack
6407914301	-	.75" W x .75" L	White	1

Additional colors can be made to order (minimum quantities apply.)

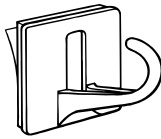

Plastic J-Hook J-106

- Permanent adhesive back for easy installation to most surfaces
- Shown with Plastic Double C-Hook
- White polystyrene
- Packaged: 8 pieces/sheet

Item No.	Ref. No.	Dim.	Finish	Pack
6407961301	-	1" W x 1" L	White	8 pieces/sheet

Additional colors can be made to order (minimum quantities apply.)

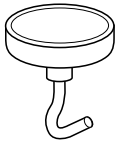

Magnetic Adapter with Hook

- Versatile magnetic hook can be used to hold ceiling displays, merchandising strips, signs and more
- Installs securely on most metal surfaces
- Available in 1" diameter with 9 lb pull or 1.25" diameter with 14 lb pull
- White steel

Item No.	Ref. No.	Dimensions	Finish	Pack
8602789901	-	1" dia	White	1
8602789902	-	1.25" dia	White	1

Additional sizes can be made to order (minimum quantities apply.)

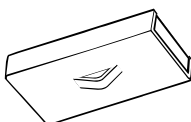

Magnetic Ceiling Loop

- Suspend ceiling accessories from metal grid in seconds
- Loop securely holds hooks, wire, cord or chain
- Shown with Metal Double C-Hook
- Chrome housing

Item No.	Ref. No.	Dimensions	Finish	Pack
6408957900	-	1" W x 2" L	Chrome	1

WARNING: Maximum recommended weight for all ceiling banner systems and accessories is 3 lb per ceiling attachment.

Spiral Ceiling Loop

- Screws into acoustical ceiling tiles
- Allows ceiling attachment between standard grids
- .290" diameter loop
- Shown with Tangle-Free Cord with Barbs
- 040" steel wire



Item No.	Ref. No.	Dimensions	Finish	Pack
6401028100	R16-CC006	1.25" L	Steel	1

Ceiling Hanger HC-87

- Easy-to-use design works with most ceiling grid systems
- Easy to attach; just squeeze and release sides
- Works with S-Hooks and Double C-Hooks
- Shown with Metal Double C-Hook
- Available with 6' L black cord with barb or clear monofilament with barb, or without cord
- Steel wire

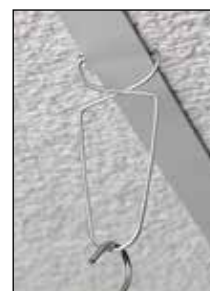

Without Cord

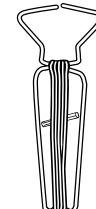

Black Cord

Item No.	Ref. No.	Cord	Finish	Pack
6402151901	RCH-092	w/o cord	Steel	1
6402151904	R16-CC005-6	Clear	Steel	1

DO NOT HANG BANNERS DIRECTLY FROM BARBS — CORD MUST BE TIED TO ITS ATTACHMENT.

Wire Mobile Hanger 7010

- Sturdy metal construction and easy height adjustment
- Unwrap filament to adjust length
- Includes 5' of barbed monofilament
- Steel wire



Item No.	Ref. No.	Dimensions	Finish	Pack
6407455600	-	5" L	Steel	1

DO NOT HANG BANNERS DIRECTLY FROM BARBS — CORD MUST BE TIED TO ITS ATTACHMENT.



Mobile Spring

- Hang displays at exactly the height you want
- Available in 4' stretched lengths
- Steel wire
- 4' packaged: 100/bag; Sold in full bags only

Item No.	Ref. No.	Actual	Stretched	Pack
6401642801	-	6" L	4' L	100



Metal Double C-Hook

- All-purpose galvanized steel hook holds banners securely and resists bending
- .085" diameter galvanized steel wire
- Packaged: 50/bundle; Sold in full bundles only

Item No.	Ref. No.	Dimensions	Finish	Pack
6407842809	RWCH-4-092	4" L	Steel	50
6407842801	RWCH-6-092	6" L	Steel	50
6407842813	RWCH-8-092	8" L	Steel	50
6407842802	RWCH-12-092	12" L	Steel	50
6407842814	RWCH-16-092	16" L	Steel	50
6407842804	RWCH-24-092	24" L	Steel	50
6407842806	RWCH-36-092	36" L	Steel	50

Additional lengths can be made to order (minimum quantities apply.)



Open



Locking

Plastic Double C-Hook

- This clear hook puts the emphasis on the banner, not the hardware
- Available in two styles: Open C-Hook and Locking C-Hook
- Clear polycarbonate

Item No.	Ref. No.	Style	Dimensions	Pack
6408034201	-	Open	4" L	1
6408034202	-	Open	6" L	1
6408034203	-	Open	8" L	1
6408034204	-	Open	12" L	1
6408034205	-	Open	16" L	1
6400944312	-	Locking	12" L	1
6400944313	-	Locking	18" L	1

Additional lengths can be made to order (minimum quantities apply.)

WARNING: Maximum recommended weight for all ceiling banner systems and accessories is 3 lb per ceiling attachment.

Tangle-Free Cord with Barbs

- Hold signs and displays securely in place with these nylon cords
- White nylon
- Black also available, call for details
- Packaged: 100/bag; Sold in full bags only



Item No.	Ref. No.	Dimensions	Finish	Pack
6508106218	-	18" L	White	100

Additional lengths and colors can be made to order (minimum quantities apply.)
 DO NOT HANG BANNERS DIRECTLY FROM BARBS — CORD MUST BE TIED TO ITS ATTACHMENT.

Monofilament Cord with Barb

- Clear cord provides near-invisible presentation
- Holds signs and displays securely
- Clear monofilament
- Packaged: 100/bag; Sold in full bags only



Item No.	Ref. No.	Dimensions	Finish	Pack
6507809504	-	2" L	Clear	100
6507809505	-	3" L	Clear	100
6507809506	-	4" L	Clear	100
6507809507	-	6" L	Clear	100
6507809508	-	8" L	Clear	100
6507809500	-	12" L	Clear	100
6507809502	-	18" L	Clear	100
6507809511	-	24" L	Clear	100
6507809548	-	48" L	Clear	100

Additional lengths can be made to order (minimum quantities apply.)
 DO NOT HANG BANNERS DIRECTLY FROM BARBS — CORD MUST BE TIED TO ITS ATTACHMENT.

Elastic Cord with Barbs

- Durable elastic cords hold signs and displays securely in place
- Stretches to approximately twice its length
- Black polyester
- Packaged: 100/bag; Sold in full bags only



Item No.	Ref. No.	Dimensions	Finish	Pack
6504440706	-	1" L	Black	100
6504440701	-	2" L	Black	100
6504440707	-	3" L	Black	100
6504440703	-	6" L	Black	100
6504440704	-	8" L	Black	100
6504440708	-	12" L	Black	100
6504440709	-	18" L	Black	100

Additional lengths and colors can be made to order (minimum quantities apply.)
 DO NOT HANG BANNERS DIRECTLY FROM BARBS — CORD MUST BE TIED TO ITS ATTACHMENT.



Ceiling Cable

- Sturdy cable securely hangs heavier ceiling signage
- .5" loop at each end holds materials up to .375" diameter
- .031" diameter wire
- Holds up to 22 lb (Note: standard ceiling grid holds a maximum of 3 lb)
- Shown with Aluminum Ceiling Hook

Item No.	Ref. No.	Dimensions	Finish	Pack
6409606701	R16-LEC-6	6" L	Steel	1
6409606702	R16-LEC-12	12" L	Steel	1
6409606703	R16-LEC-18	18" L	Steel	1
6409606706	R16-LEC-24	24" L	Steel	1
6409606724	R16-LEC-36	36" L	Steel	1
6409606727	-	48" L	Steel	1

Additional lengths can be made to order (minimum quantities apply.)

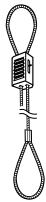

Adjustable Ceiling Cable

- Adjust ceiling display height quickly and easily
- Innovative cable adjuster provides tool-free height adjustment
- One end of cable forms a fixed loop; other end is open for infinite adjustment with cable adjuster
- Strong .0625" diameter cable holds up to 75 lb
- Available bulk, or polybagged as an unassembled kit
- Shown with Elite™ Square Aluminum Banner Hanging System
- Steel cables and adjusters

Item No.	Ref. No.	Style	Dimensions	Pack
6401020005	-	Bulk	5' L	1
6401020010	-	Bulk	10' L	1
6401020015	-	Bulk	15' L	1

CEILING DISPLAYS

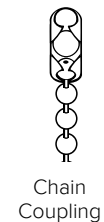

Chain Coupling

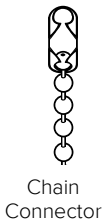

Chain Connector



Connector

Beaded Chain

- Add product information, color chips and promotional signage almost anywhere in store
- Chain clips together for a secure fit
- Available in connector and coupling styles
- Connector style provides a solid attachment with fixed chain length
- Coupling style allows chain to adjust to any length
- Connector can be used for a solid attachment and fixed length
- #3 and #6 nickel chain

Item No.	Ref. No.	Style	Chain	Dia.	Dim.	Pack
6402212505	-	Chain Coupling	#6	.125"	6" L	1
6402212506	-	Chain Coupling	#6	.125"	12" L	1
6402212507	-	Chain Coupling	#6	.125"	24" L	1
6402293801	-	Chain Connector	#3	.093"	6" L	1
6402293802	-	Chain Connector	#3	.093"	12" L	1
6402212501	-	Chain Connector	#6	.125"	6" L	1
6402212502	-	Chain Connector	#6	.125"	12" L	1
6402212503	-	Chain Connector	#6	.125"	24" L	1

Additional sizes can be made to order (minimum quantities apply.)

WARNING: Maximum recommended weight for all ceiling banner systems and accessories is 3 lb per ceiling attachment.

Beaded Chain with A-Hooks

- Use chain to hang promotional signage, product information, or banner displays almost anywhere in store
- Hook style allows easy hanging of chains from ceiling or hanging accessories
- Hook: 1.25" H x .6875" W; .375" H x .25" W inner dimension to hook onto attachment
- #6 silver nickel-plated brass



Item No.	Ref. No.	Chain	Dimensions	Pack
640000012	-	#6	12" L	1

Additional sizes can be made to order (minimum quantities apply).

Metal Chain

- Hang displays safely and attractively
- Single jack chain made with bright galvanized steel on plastic spools
- #16 wire (.062" diameter) holds 10 lbs
- #12 wire (.105" diameter) holds 29 lbs
- Sold in full rolls only



Item No.	Ref. No.	Dimensions	Finish	Pack
6402031405	R16-CHN16250	#16 x 200' Roll	Galv.	1

Jack Chain Kit JC-48S

- Hang displays and signs easily and with confidence
- Each kit includes two #16 x 48" L chains and four 1" S-Hooks
- Plated steel



Item No.	Ref. No.	Dimensions	Finish	Pack
6401739901	R16-CHNK24S4	48" L Chain	Steel	1 Kit

Additional lengths can be made to order (minimum quantities apply)



S-Hook

- S-Hook has multiple uses
- 1" overall length
- 080" diameter nickel-plated wire

Item No.	Ref. No.	Dimensions	Finish	Pack
7907471301	-	1" L	Silver	1

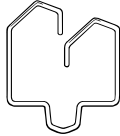

Warehouse Ceiling Hook for Solid Beam

- Hang banners from solid beams
- Innovative design
- 11-gauge wire, holds up to 7 lb
- Can be easily installed with an Installation Pole (below)
- Durable zinc-plated wire

Item No.	Ref. No.	Dimensions	Finish	Pack
6409059101	-	6" W x 9" H	Silver	1

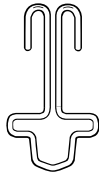

Warehouse Ceiling Hook for Split Beam

- Hang banners from split beams
- Innovative design
- 11-gauge wire, holds up to 7 lb
- Can be easily installed with an Installation Pole (below)
- Durable zinc-plated wire

Item No.	Ref. No.	Dimensions	Finish	Pack
6400591901	-	4.25" W x 7.25" H	Silver	1



Installation Pole

- Hang ceiling displays and accessories quickly and easily
- Telescopic aluminum poles extend to 10' or 18'

Item No.	Ref. No.	Dimensions	Finish	Pack
6302171000	-	10' L	Aluminum	1
6301897101	-	18' L	Aluminum	1

WARNING: Maximum recommended weight for all ceiling banner systems and accessories is 3 lb per ceiling attachment.

The Next Generation in Sign Holders & Ceiling Displays



Phone **800.422.2547**
 Fax **800.422.2502**
 Web **www.siffron.com**

call toll-free in North America
 fax us your purchase order
 find and buy resources online



siffron[®]

See more great solutions
on our website!

www.siffron.com
800.422.2547